

Using Your Personal Computer

PC 330 (Type 6577) and PC 350 (Type 6587)



Using Your Personal Computer

PC 330 (Type 6577) and PC 350 (Type 6587)

Note

Before using this information and the product it supports, be sure to read the general information under Appendix B, "Product Warranties, License Agreement, and Notices" on page 73.

Second Edition (June 1996)

The following paragraph does not apply to the United Kingdom or any country where such provisions are inconsistent with local law: INTERNATIONAL BUSINESS MACHINES CORPORATION PROVIDES THIS PUBLICATION "AS IS" WITHOUT WARRANTY OF ANY KIND, EITHER EXPRESS OR IMPLIED, INCLUDING, BUT NOT LIMITED TO, THE IMPLIED WARRANTIES OF MERCHANTABILITY OR FITNESS FOR A PARTICULAR PURPOSE. Some states do not allow disclaimer of express or implied warranties in certain transactions, therefore, this statement may not apply to you.

This publication could include technical inaccuracies or typographical errors. Changes are periodically made to the information herein; these changes will be incorporated in new editions of the publication. IBM may make improvements and/or changes in the product(s) and/or the program(s) described in this publication at any time.

It is possible that this publication may contain reference to, or information about, IBM products (machines and programs), programming, or services that are not announced in your country. Such references or information must not be construed to mean that IBM intends to announce such IBM products, programming, or services in your country.

Requests for technical information about IBM products should be made to your IBM reseller or IBM marketing representative.

© Copyright International Business Machines Corporation 1996. All rights reserved.

Note to U.S. Government Users — Documentation related to restricted rights — Use, duplication or disclosure is subject to restrictions set forth in GSA ADP Schedule Contract with IBM Corp.

Contents

Safety Information	v	Diskettes	28
Lithium Battery Notice	vi	Identifying Diskettes	29
Laser Compliance Statement	vii	Handling and Storing Diskettes	31
 		Labeling Diskettes	32
Chapter 1. Your Personal Computer	1	Inserting and Removing Diskettes	33
What Your Personal Computer Offers	1	Write-Protecting Diskettes	34
Features	1	Formatting Diskettes	35
Expandability	4	Copying Diskettes	35
Features at a Glance—Personal Computer	7	Using a CD-ROM Drive	36
 		Handling Compact Discs	36
Chapter 2. Arranging Your Workspace	9	Loading a Compact Disc	36
Comfort	9	Using Locks	37
Glare and Lighting	9	Locking the Cover and Sliding Door	37
Air Circulation	10	Locking the Keyboard	38
Electrical Outlets and Cable Lengths	10	 	
 		Chapter 4. Taking Care of Your Personal Computer	39
Chapter 3. Operating Your Personal Computer	11	Basics	39
Using Controls and Status Indicators	11	Cleaning Your Personal Computer	39
Starting Your Personal Computer	13	Computer and Keyboard	39
Using a Mouse	13	Monitor Screen	39
Shutting Down	14	Mouse	40
Configuring Your Personal Computer	15	Replacing the Battery	40
Using the Configuration/Setup Utility Program	16	Moving Your Personal Computer	41
Viewing the System Summary	16	 	
Setting the Date and Time	17	Chapter 5. Solving Problems	43
Passwords	17	Using Diagnostic Tools	43
Using Advanced Power Management	21	Power-On Self-Test (POST)	43
Using System Management	23	POST Beep Codes	44
Changing Keyboard Speed	23	Diagnostic Programs	44
Changing Monitor Settings	24	Error Messages	45
Installing Video Device Drivers	25	POST Messages	46
Adding Memory Modules	26	Troubleshooting Charts	54
Updating System Programs	27	Installing Files from Option Diskettes	62

Managing TSR Programs	62	Serial Numbers and Keys	69
Chapter 6. Getting Help, Service, and Information	63	Device Records	71
Solving Problems	63	Appendix B. Product Warranties, License	
Using the HelpWare Support Family	63	Agreement, and Notices	73
Using Electronic Support Services	63	Hardware Limited Warranty	73
Getting Information by Fax	64	License Information	75
Getting Help Online	64	Program Name	75
Getting Help by Telephone	65	Additional Terms and Conditions	75
Getting Help Around the World	65	Program Services	75
Purchasing Additional HelpWare Services	66	Warranty	75
Enhanced PC Support Line	66	U.S. Government Users Restricted Rights	75
900-Number Operating System and Hardware		Other Documentation	75
Support Line	66	Other Additional Terms and Conditions	76
Network and Server Support Line	66	Notices	77
Ordering Support Line Services	67	Trademarks	77
Warranty and Repair Services	67	Electronic Emission Notices	78
Obtaining IBM Operating System Updates	68	Telecommunication Notices	79
Ordering Publications	68	Power Cord Notice	81
Appendix A. Computer Records	69	Index	83

Safety Information



DANGER:

Electrical current from power, telephone, and communication cables is hazardous. To avoid shock hazard, connect and disconnect cables as shown below when installing, moving or opening the covers of this product or attached devices. The power cord must be used with a properly grounded outlet.

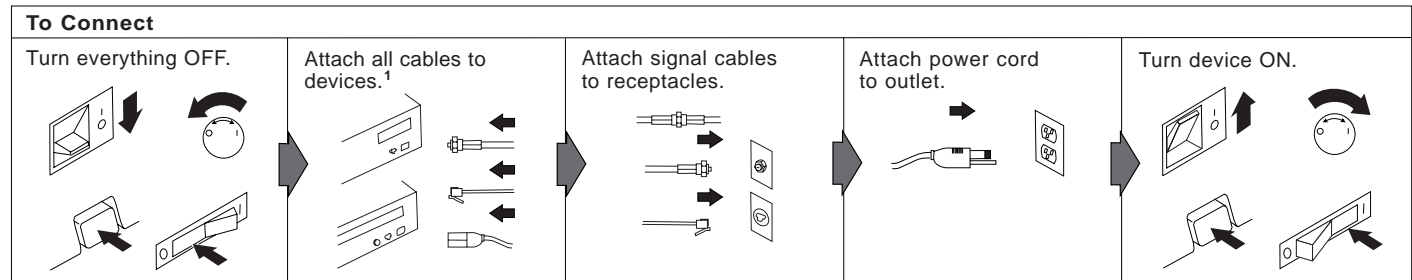

¹ In the U.K., by law, the telephone cable must be connected after the power cord.

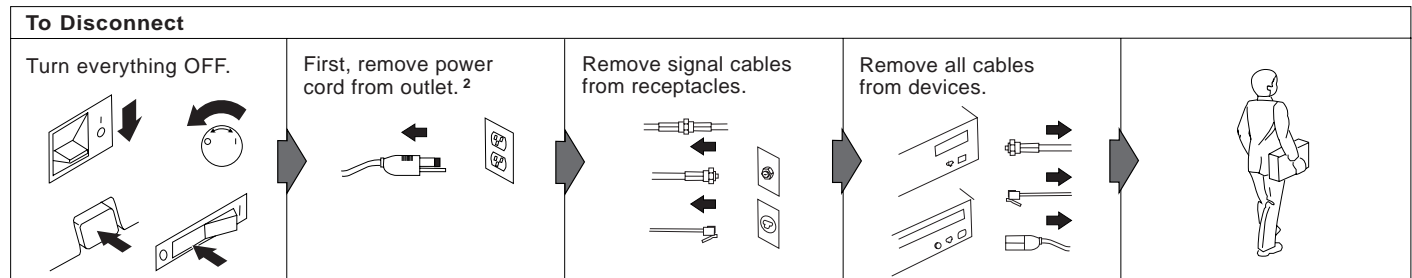

² In the U.K., by law, the power cord must be disconnected after the telephone line cable.

Lithium Battery Notice

CAUTION:

Danger of explosion if battery is incorrectly replaced.

When replacing the battery, use only IBM Part Number 33F8354 or an equivalent type battery recommended by the manufacturer. The battery contains lithium and can explode if not properly used, handled, or disposed of.

Do not:

- **Throw or immerse into water**
- **Heat to more than 100°C (212°F)**
- **Repair or disassemble**

Dispose of the battery as required by local ordinances or regulations.

ATTENTION

Danger d'explosion en cas de remplacement incorrect de la batterie.

Remplacer uniquement par une batterie IBM de type 33F8354 ou d'un type équivalent recommandé par le fabricant. La batterie contient du lithium et peut exploser en cas de mauvaise utilisation, de mauvaise manipulation ou de mise au rebut inappropriée.

Ne pas :

- **Lancer ou plonger dans l'eau**
- **Chauffer à plus de 100° C (212° F)**
- **Réparer ou désassembler**

Mettre au rebut les batteries usagées conformément aux règlements locaux.

Laser Compliance Statement

Some IBM Personal Computer models are equipped from the factory with a CD-ROM drive. The CD-ROM drive is a laser product. The CD-ROM drive is certified in the U.S. to conform to the requirements of the Department of Health and Human Services 21 Code of Federal Regulations (DHHS 21 CFR) Subchapter J for Class 1 laser products. Elsewhere, the drive is certified to conform to the requirements of the Electrotechnical Commission (IEC) 825 and CENELEC EN 60 825 for Class 1 laser products.

Class 1 laser products are not considered to be hazardous.

Chapter 1. Your Personal Computer

Thank you for selecting an IBM Personal Computer.

This manual contains information about operating and taking care of your personal computer and solving problems that might occur. For more detailed information or a discussion of some of the more technical aspects of your personal computer, refer to *Understanding Your Personal Computer*. If your personal computer comes with preinstalled software, a convenient online version of *Understanding Your Personal Computer* is included. You can print any portion or all of the online *Understanding Your Personal Computer*. The printed version is also available for separate purchase. For more information, see “Ordering Publications” on page 68.

If you need to install an option, such as an adapter, memory, microprocessor upgrade, or security option, refer to *Installing Options in Your Personal Computer*, which is included with your personal computer.

What Your Personal Computer Offers

Your IBM Personal Computer incorporates many of the latest advances in personal computer technology and is easy to expand and upgrade as your needs change.

Features

This section briefly discusses some of the features of your personal computer. For an easy-to-read summary of the

features, see “Features at a Glance—Personal Computer” on page 7.

Throughout this manual, the two Personal Computer models are distinguished by their number of drive bays and expansion slots. A *PC 330* model has three drive bays and three expansion slots and, a *PC 350* model has five drive bays and five expansion slots.

Support for Pentium Microprocessors

At the core of these powerful computers is an Intel Pentium microprocessor. This microprocessor gives you the power and speed you need to take full advantage of even the most complex business and desktop-publishing programs. Microprocessor upgrades are available.

PCI Bus

In addition to industry standard architecture (ISA) bus expansion slots, your personal computer has a high-performance, industry-standard peripheral component interconnect (PCI) internal bus. The PCI bus speeds up the exchange of information between the microprocessor and peripheral devices within your personal computer, improving the performance of both the video monitor and the hard disk drives.

ISA/PCI Adapter Expansion Slots

The *PC 330* and *PC 350* have three shared ISA/PCI adapter expansion slots on a riser card. In addition, the *PC 350* provides two dedicated ISA adapter expansion

slots. Using these ISA/PCI expansion slots, you can install devices such as a video or graphics adapter, a small computer system interface (SCSI) adapter, or a local area network (LAN) adapter.

High-Capacity Hard Disk Drives

Your personal computer comes with an enhanced integrated drive electronics (IDE) controller installed. It supports up to four IDE high-capacity hard disk drives.

ECP/EPP Parallel Port

The extended capabilities port (ECP)/enhanced parallel port (EPP) feature means faster printing of your documents. It also gives you the capability of attaching communication and storage devices to the parallel port in addition to printers.

Serial Ports

Your personal computer comes with ports for connecting input/output (I/O) devices such as printers and modems. One standard, 16550-UART serial port comes installed on your machine.

Universal Serial Bus Connectors

In addition to a 16550-UART serial port, your personal computer comes with two *universal serial bus (USB)* interfaces. USB allows you to connect multiple I/O

devices that previously used serial, parallel, keyboard, mouse and game ports. Because USB uses Plug and Play technology, you can add additional devices without reconfiguring and powering down your personal computer.

Other advantages to USB connectivity include support for multimedia and telephony devices, more speed than previous standard ports, and the potential, multiple connections you can employ to customize your personal computer.

Infrared Port

Your personal computer comes with an infrared port where you can connect an optional infrared transceiver module. This enables you to transfer data to and from other infrared-capable computers or printers.

Ease-of-Use Features

Your IBM Personal Computer includes many ease-of-use features, such as Plug and Play technology and graphical diagnostic programs.

Plug and Play technology makes adding options easier. Support for Plug and Play technology is built into the system board of your personal computer. When you add an adapter, it is automatically configured as part of the computer, or you use a setup utility program to integrate it. In many cases, no switches or jumpers have to be set inside your personal computer.

For information about Plug and Play technology with various types of adapters, see *Understanding Your Personal Computer*.

If you have a problem with your personal computer, an easy-to-use graphical diagnostic program can help you determine whether the hardware is causing the problem.

Advanced Power Management

Energy conservation is an important concern, and the IBM Personal Computer is designed with this concern in mind. Energy-saving features are available in the system software.

Ergonomic Features

Your personal computer provides features that make components easier to adjust for personal comfort, and usability.

Security Features

The security features for personal computer protect both hardware and software. For example, power-on and administrator passwords can be set so that unauthorized persons do not gain access to your personal computer and software. A cover keylock prevents tampering with your personal computer. A lockable sliding door restricts access to the removable-media bays. You can select a secure start-up sequence so that only certain drives are available.

For a list of security features, see “Features at a Glance—Personal Computer” on page 7.

Operating-System Support

The personal computer is designed to use a variety of operating systems to meet your particular needs. You can use the following operating systems with your personal computer:

- IBM OS/2
- IBM OS/2 Warp Connect
- IBM PC DOS
- DEC PathWorks
- DOS with Microsoft Windows
- DOS with Microsoft Windows for Work Groups
- MS-DOS
- Novell NetWare
- Novell UnixWare
- Solaris
- Windows 95
- Windows NT

Service and Support

You can obtain assistance for using your personal computer, as well as service, from a number of sources. Help is available by phone, fax, and modem. For detailed information, see Chapter 6, “Getting Help, Service, and Information” on page 63.

Expandability

You can easily expand the capabilities of your personal computer by adding system memory, adapters that use the ISA/PCI expansion slots, additional hard disk drives, diskette drives, or a CD-ROM drive.

Connectivity

If your personal computer is equipped with an Ethernet or token ring adapter, it is enabled for connection to a network. Refer to your operating system documentation for more information.

If your personal computer is equipped with an Ethernet or token ring adapter that supports the LAN Wake-Up, your personal computer can be started by a signal sent from another computer on the LAN.

PCMCIA Ports

You can add optional *Personal Computer Memory Card International Association (PCMCIA)* connectors to your personal computer. PCMCIA support allows you to expand the I/O and storage capabilities of the computer. PCMCIA devices are the size of a credit card and are called *PC Cards*.

With a PCMCIA option, your personal computer can have two 68-pin PCMCIA connectors (or *sockets*) on the front panel. Each socket can accept type-1, -2, or -3 PC Cards. Inside the computer, the sockets are connected to a *PCMCIA adapter* in an I/O expansion slot. Some PCMCIA adapters have two additional sockets at the back of the computer. You can insert and remove most PC Cards without turning off the computer.

Drive Locations

The following illustrations show the locations of hard disk drives, diskette drives, and other features of your personal computer.

PC 330

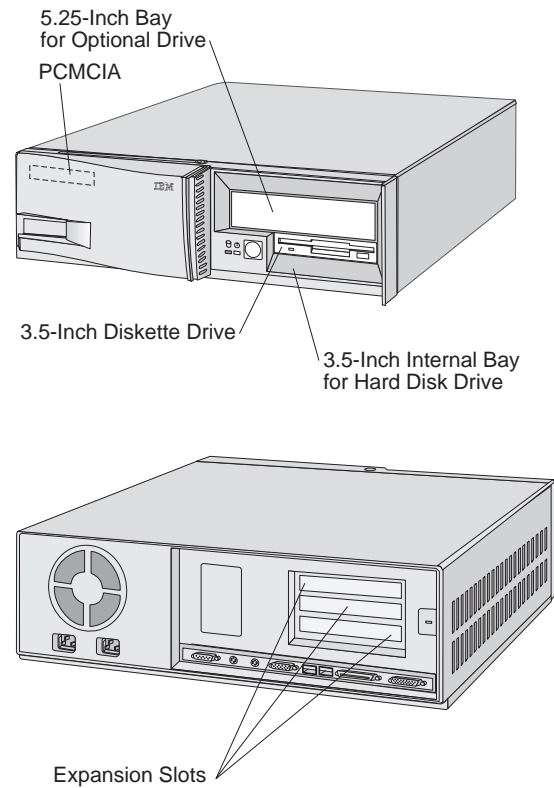

PC 350

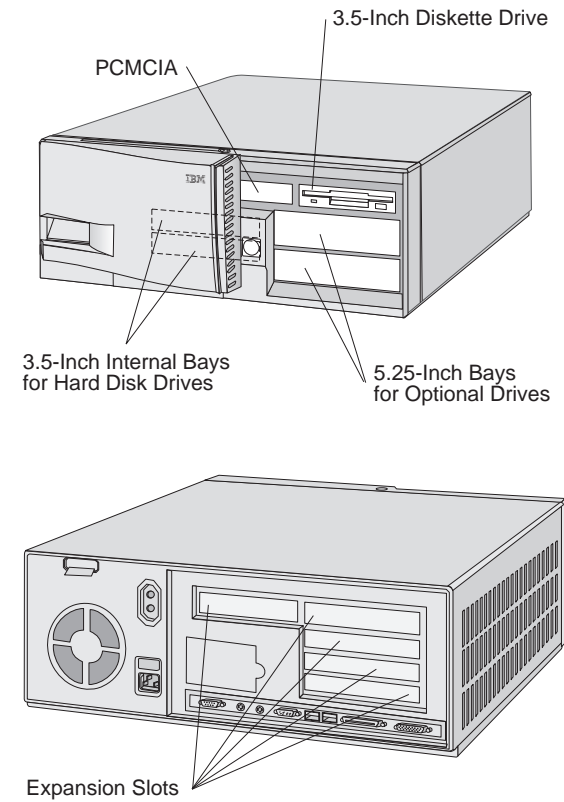

Input and Output Connectors

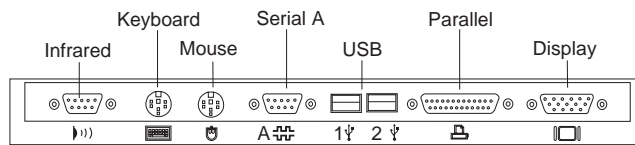
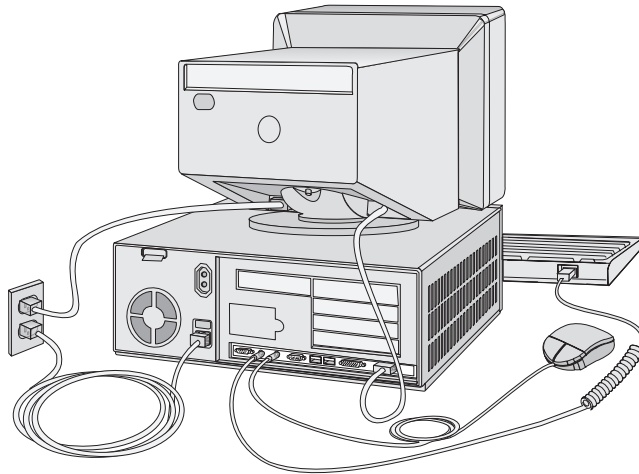

Features at a Glance—Personal Computer

The following table summarizes the available features in the IBM PC 330 and PC 350. More information about the features of your personal computer can be found in the Configuration/Setup Utility program. Refer to “Configuring Your Personal Computer” on page 15.

<p>Packages</p> <ul style="list-style-type: none"> • PC 330: Three slots, three drive bays • PC 350: Five slots, five drive bays <p>Microprocessor</p> <ul style="list-style-type: none"> • Intel Pentium processor • The system board is designed to support microprocessor speeds from 75 MHz to 200 MHz (50, 60, or 66 MHz externally) <p>Memory</p> <ul style="list-style-type: none"> • 192 MB maximum addressable (parity or nonparity) • 60 ns fast page or enhanced data output (EDO) • Four 72-pin SIMM sockets in two banks <ul style="list-style-type: none"> – Modules in 4, 8, 16, or 32 MB units – Matched pair required in each bank • One 168-pin DIMM socket: 8, 16, or 32 MB unit • Flash memory for POST/BIOS <p>Level-2 Cache</p> <ul style="list-style-type: none"> • 256 KB upgradable to 512 KB <p>Monitor Support</p> <ul style="list-style-type: none"> • SVGA • Power-management capable <p>Diskette Drives</p> <ul style="list-style-type: none"> • Standard: One 3.5-inch 1.44 MB drive • Maximum: Two • Options: <ul style="list-style-type: none"> – 5.25-inch 1.22 MB drive – 3.5-inch 1.44 MB or 2.88 MB drive 	<p>Hard Disk Drives</p> <ul style="list-style-type: none"> • Standard: One PCI bus-master IDE drive • Maximum: Four <p>Input/Output Features</p> <ul style="list-style-type: none"> • ECP/EPP parallel port • One 16550-UART serial port • Two universal serial bus (USB) interfaces • One infrared port • Video port • PS/2 mouse • 104-key keyboard, Windows 95 compatible <p>Video</p> <ul style="list-style-type: none"> • Accelerated SVGA attached to PCI bus • 1 MB DRAM video memory upgradable to 2 MB <p>Expansion</p> <ul style="list-style-type: none"> • Pentium OverDrive socket • ISA/PCI Plug and Play support <p>Power</p> <ul style="list-style-type: none"> • PC 330: 145 W, 115/230 V ac, 50/60 Hz • PC 350: 200 W, 115/230 V ac, 50/60 Hz • Built-in overload and surge protection • Advanced power management 	<p>Security</p> <ul style="list-style-type: none"> • Power-on password • Administrator password • ISA/PCI riser card • Startup sequence control • Startup without diskette drive, keyboard, mouse • Unattended Start mode (network) • Diskette I/O control • Hard disk I/O control • Serial and parallel port I/O control • Lockable cover • Secure hard disk • Software-readable hardware IDs <p>System Management</p> <ul style="list-style-type: none"> • LAN Wake-Up • Wake Up on Ring • Wake Up on Alarm <p>Operating System Support</p> <ul style="list-style-type: none"> • IBM OS/2 • IBM OS/2 Warp Connect • IBM PC DOS • DEC PathWorks • DOS with Microsoft Windows • DOS with Microsoft Windows for Work Groups • MS-DOS • Novell NetWare • Novell UnixWare • Solaris • Windows 95 • Windows NT
---	---	--

Chapter 2. Arranging Your Workspace

To get the most from your computer, arrange both the equipment you use and your work area to suit your needs and the kind of work you do. Your comfort is of foremost importance, but light sources, air circulation, and the location of electrical outlets also can affect the way you arrange your workspace.

Comfort

Although no single working position is ideal for everyone, here are a few guidelines to help you find a position that suits you best.

Sitting in the same position for a long time causes fatigue. A good chair can make a big difference. The backrest and seat should adjust independently and provide good support. The seat should have a curved front to relieve pressure on the thighs. Adjust the seat so that your thighs are parallel to the floor and your feet are either flat on the floor or on a footrest.

When using the keyboard, keep your forearms parallel to the floor and your wrists in a neutral, comfortable position. Try to keep a light touch on the keyboard and your hands and fingers relaxed. You can change the angle of the keyboard for maximum comfort by adjusting the position of the keyboard feet.

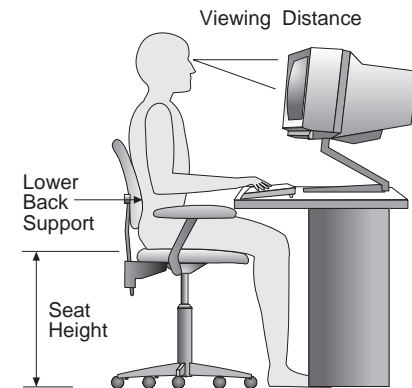

Adjust the monitor so the top of the screen is at, or slightly below, eye level. Place the monitor at a comfortable viewing distance, usually 51 to 61 cm (20 to 24 in.), and position it so you can view it without having to twist your body. Also position other equipment you use regularly, such as the telephone or a mouse, within easy reach.

Glare and Lighting

Position the monitor to minimize glare and reflections from overhead lights, windows, and other light sources. Even reflected light from shiny surfaces can cause annoying reflections on your monitor screen. Place the monitor at right angles to windows and other light sources, when possible. Reduce overhead lighting, if necessary, by turning off lights or using lower wattage bulbs. If you install the monitor near a window, use curtains or blinds to block the sunlight. You might have

to adjust the Brightness and Contrast controls on the monitor as the room lighting changes throughout the day.

Where it is impossible to avoid reflections or to adjust the lighting, an antiglare filter placed over the screen might be helpful. However, these filters might affect the clarity of the image on the screen; try them only after you have exhausted other methods of reducing glare.

Dust buildup compounds problems associated with glare. Remember to clean your monitor screen periodically using a soft cloth moistened with a nonabrasive liquid glass cleaner.

Air Circulation

Your computer and monitor produce heat. The computer has a fan that pulls in fresh air and forces out hot air. The monitor lets hot air escape through vents. Blocking the air vents can cause overheating, which might result in a malfunction or damage. Place the computer and monitor so that nothing blocks the air vents; usually, 51

mm (2 in.) of air space is sufficient. Also, make sure the vented air is not blowing on someone else.

Electrical Outlets and Cable Lengths

The location of electrical outlets and the length of power cords and cables that connect to the monitor, printer, and other devices might determine the final placement of your computer.

When arranging your workspace:

- Avoid the use of extension cords. When possible, plug the computer power cord directly into an electrical outlet.
- Keep power cords and cables neatly routed away from walkways and other areas where they might get kicked accidentally.

For more information about power cords, see “Power Cord Notice” on page 81.

Chapter 3. Operating Your Personal Computer

This chapter provides information to help you in the day-to-day use of your personal computer.

Using Controls and Status Indicators

The following operating controls and status indicators are located on the front of your personal computer:

Power Switch: Press this switch to turn your personal computer on or off. Do not turn off your personal computer if the in-use light for the hard disk drive or diskette drive is on.

Power-On Light: This status indicator lights when you turn on your personal computer.

Hard-Disk Drive Light: When this light is on, it indicates that your personal computer is reading from or writing to the hard disk.

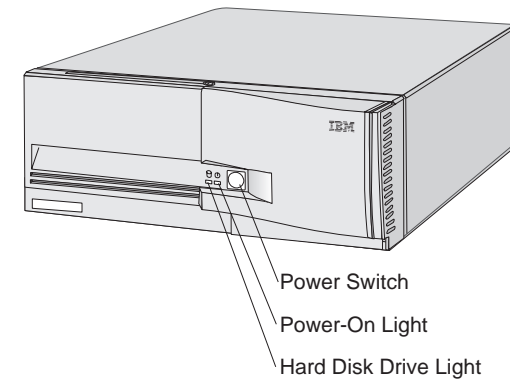

For both models (door closed)

Diskette Eject Button: Push this button to release a diskette from the drive.

Diskette Drive Light: When this light is on, it indicates that your personal computer is reading from or writing to a diskette.

Cover and Door Lock: The cover lock secures the cover and the sliding door on your computer, to deter tampering with or theft of the internal components.

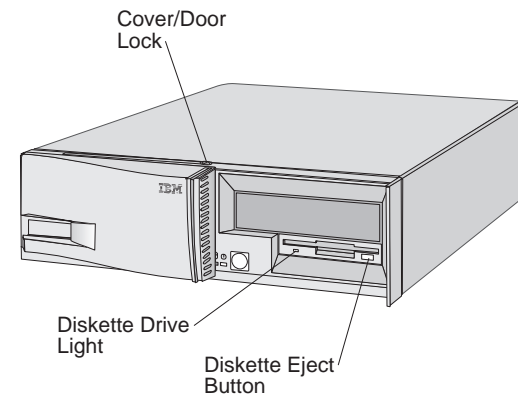

PC 330 (door open)

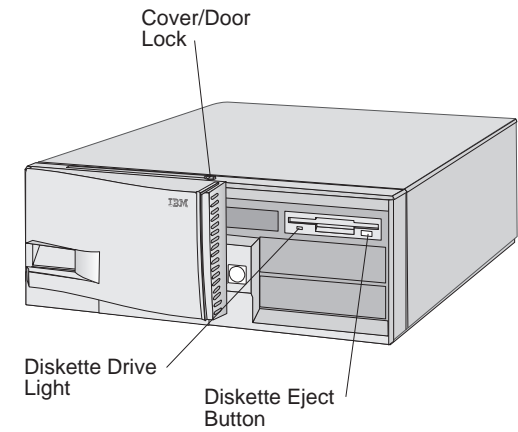

PC 350 (door open)

Starting Your Personal Computer

1. Turn on all external devices, and then turn on your personal computer. Watch the screen, and listen for a beep.

Note: If a power-on password has been set, the Enter password message appears on the screen. Type the correct password; then press **Enter** to continue.

Numbers indicating the amount of memory appear in the top-left corner of the screen. Your personal computer is running the power-on self-test (POST). The Configuration/Setup Utility program symbol appears in the top-right corner of the screen.

- If POST finishes without detecting a problem, you hear one beep, and the first screen of your operating system or application program appears.
 - If POST detects a problem, you hear multiple beeps or no beep, and an error code and a description of the error appear. If the problem might be corrected by a change in a configuration setting, the Configuration/Setup Utility program starts automatically, allowing you to attempt to correct the problem. If you need assistance, contact your service representative.
 - If there is no beep, refer to “Troubleshooting Charts” on page 54. You might need to have your personal computer serviced.
2. If there is a problem, find your personal computer response in the following table; then go to the specified section.

Computer Response	Go to:
After more than one beep, application program or operating system appears.	“Diagnostic Programs” on page 44.
Blank screen, unreadable screen, or other unusual response occurs.	“Troubleshooting Charts” on page 54.
POST error code or message appears.	“Error Messages” on page 45.

Using a Mouse

A *mouse* is a device that you use to point to and select objects on the monitor screen. It connects to your personal computer by a cable. Some mouse devices (PS/2 mice) are designed for the round mouse connector on the back of your personal computer, and others (serial mice) are designed for the D-shaped serial connector. You can use either type of mouse, if the correct software (device driver) is installed.

With a mouse, you can move the *pointer* on the monitor screen. If you have never used a mouse before, it might feel a bit awkward at first. However, with a little practice, the mouse movements will seem natural.

Place the mouse beside the keyboard on a flat surface or *mouse pad*. (A mouse pad is a flat, smooth foam rubber pad available at most computer stores.) The mouse has a

ball on the bottom, so working on a flat, smooth surface is important. You can use your right or left hand to control the mouse, depending on the hand you are most comfortable using.

Notice that the mouse has two buttons on the top (some mice have more buttons). Rest your hand comfortably on the mouse with your index finger on the left button (if you are using your right hand). IBM mouse programs provide the option to set up the mouse for left-hand use. When a mouse is set up for left-hand use, the button functions are reversed.

Use the left button to select and open objects with the mouse. Some programs also use the right button in various ways.

To use the mouse, slide it from side to side and forward and backward on a flat surface. The pointer on the monitor screen moves as you move the mouse. When you see an item that you want to select on the screen, you simply move the pointer to that item (this is called *pointing*). Then you press and release the left button on the mouse (this is called *clicking*).

To learn how to use the mouse with the software in your personal computer, see the software user's guide or tutorial.

Some programs support only one mouse button, others support two, and some support three. Despite the differences, some terms are fairly standard throughout the industry.

- | | |
|---------------------|--|
| Point | Move the mouse so the pointer is on the object you want. |
| Click | Press and release the mouse button once. |
| Double-click | Rapidly press and release the mouse button twice. |
| Drag | Point to an object, press the mouse button, and hold it down as you move the mouse to relocate the object. |
| Drop | After dragging an object to a new location, release the mouse button. |

Shutting Down

When you are ready to turn off your personal computer, use an orderly shutdown procedure to prevent the loss of unsaved data or damage to your software programs.

Configuring Your Personal Computer

The Configuration/Setup Utility program is stored in the permanent memory of your personal computer. Using this program, you can view the current configuration settings or change the settings of various features. Online help is available for these features.

The following list gives a brief description of the categories that appear in the main menu of the Configuration/Setup Utility program.

- **System Summary** provides information about the current options and features in your personal computer. Included in the system summary is information about the processor, memory, video controller, caches, diskette drives, and hard disk drives. For more information, refer to “Viewing the System Summary” on page 16.
- **Product Data** provides information about the machine type/model, flash EEPROM revision label, system serial number and the BIOS date.
- **Devices and I/O Ports** allows you to view and change information about installed devices. Also, you can access extra menus to view and change setups for the serial port, parallel port, video, and IDE drives. For more information, refer to “Changing Monitor Settings” on page 24.
- **Date and Time** allows you to view and change the date and time of your computer's internal clock. For

more information, refer to “Setting the Date and Time” on page 17.

- **System Security** allows you to secure hard disk drives and diskette drives. Also, you can set, change, delete, or erase both power-on and administrator passwords. For more information, refer to “Passwords” on page 17.
- **Start Options** provides a menu for viewing or changing keyboard speeds, startup devices, virus detection and other features. For more information, refer to “Changing Keyboard Speed” on page 23.
- **Advanced Setup** provides access to menus where you can view and change settings for cache control, ROM shadowing, PCI control, and Plug and Play control.
- **ISA Legacy Resources** provides access to menus where you can view and change settings for memory resources, I/O port resources, DMA resources, and interrupt resources.
- **Advanced Power Management** allows you to view and change settings that affect the powering off or power reduction of your personal computer. For more information, refer to “Using Advanced Power Management” on page 21.

Tip

You can use the Configuration/Setup Utility program to view and change the setup of your personal computer, regardless of which operating system you are using. However, the settings you select in your operating system might override any similar settings in the Configuration/Setup Utility program.

Using the Configuration/Setup Utility Program

To use the Configuration/Setup Utility program:

1. Turn on the computer. If your personal computer is already on when you start this procedure, you must shut down the operating system, turn off the computer, wait a few seconds until all in-use lights go off, and restart it.
2. When the Configuration/Setup Utility program prompt appears on the screen during startup, press **F1**. The Configuration/Setup Utility menu appears similar to the one shown in the following figure. Any value that has changed since the last time the computer was turned off is indicated by a pointer.
3. Select the appropriate option from the Configuration/Setup Utility menu.
 - To select an option, use the up-arrow and down-arrow keys to highlight the option, and then press **Enter**.
 - Use the right-arrow and left-arrow keys to toggle between selections for a menu item.
 - Each option has a Help screen. To view the Help screen, highlight the option, and then press **F1**.
 - Press **Esc** to return to the previous menu.
4. As you exit from the Configuration/Setup Utility program, be sure to save the changes you have made. Select **Save Settings** from the Configuration/Setup Utility menu, and press **Enter**.

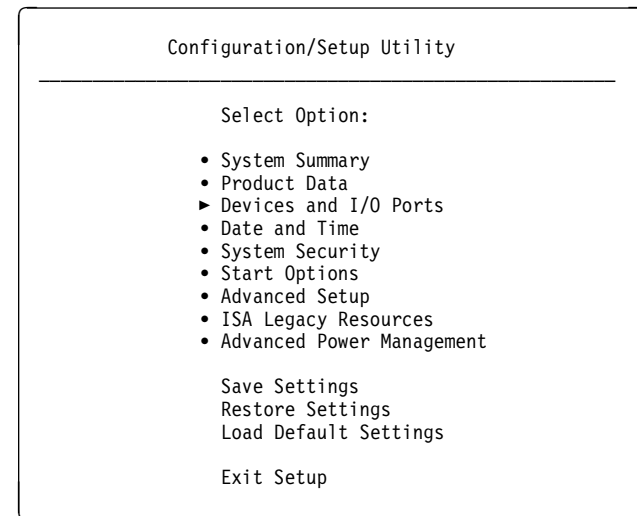

Figure 1. Configuration/Setup Utility menu

The following sections describe the tasks most personal computer users need to perform using the Configuration/Setup Utility program.

Viewing the System Summary

You can use the Configuration/Setup Utility program to view a summary of the options and features in your personal computer. To view the system summary:

1. Start the Configuration/Setup Utility program (see “Using the Configuration/Setup Utility Program”).

2. Select **System Summary** from the Configuration/Setup Utility menu. The System Summary screen appears.

Note: Depending on the model and configuration, your screen might appear slightly different from the one shown here.

System Summary	
Processor	Pentium
Processor Speed	166 MHz
Math Coprocessor	Internal
System Memory	640 KB
Extended Memory	15360 KB
Video Controller	S3 Incorporated. Trio 64V+
Cache Size	256 KB
Cache State	Enabled
Shadow RAM	384 KB
System ROM	F000h - FFFFh
Memory Type	Non-parity
Diskette Drive A:	1.44 MB 3.5"
Diskette Drive B:	Not Installed
Hard Disk Drive 0	1286 MB
Hard Disk Drive 1	Not Installed
Hard Disk Drive 2	Not Installed
Hard Disk Drive 3	Not Installed
Mouse	Installed

Figure 2. System Summary Screen

Setting the Date and Time

Your personal computer has an internal clock that maintains the date and time. A battery keeps the clock active when you turn off the computer.

To set the date and time:

1. Start the Configuration/Setup Utility program (see “Using the Configuration/Setup Utility Program” on page 16).
2. Select **Date and Time** from the Configuration/Setup Utility menu.
3. Type the date and time in the appropriate fields.
4. Press **Enter**.
5. Remember to save the changes when you exit from the Configuration/Setup Utility program.

Your operating system might also have a function for setting the date and time. Refer to your operating system documentation for more information.

Passwords

Password protection is available in several forms. You can set, change, and delete power-on and administrator passwords with the Configuration/Setup Utility program. Other password security, such as passwords that lock the keyboard, might be available through your operating system or network. See “Locking the Keyboard” on page 38.

Power-On Password

You do not need to have a power-on password to use your personal computer, but a password helps protect the information you store in it. The power-on password prevents the computer from being started by unauthorized people, or it locks the keyboard and mouse

while allowing the computer and operating system to start.

When a power-on password is set, you must type the password before the computer and operating system will start with the keyboard and mouse activated. The password does not appear on the screen as you type it. If you type the wrong password, you receive a screen message telling you so. If you type the wrong password three times, you must turn off the computer and start again. When you type the correct password, the keyboard and mouse are unlocked, and the computer begins normal operation.

If you have a PS/2 mouse (that is, if it is connected to the mouse port) it is affected by the power-on password. If your mouse is connected to a serial port, it is activated when the computer is started, regardless of whether a password is set.

When you set the power-on password, you can choose one of three password-prompt modes:

On In this mode, you are prompted for the power-on password when you turn on the computer. Until the correct password is entered, the computer will not run the CONFIG.SYS or AUTOEXEC.BAT instructions, the operating system will not start, and the keyboard will remain locked. If you have a PS/2 mouse, it also will remain locked.

Off This is the Unattended Start mode. When you turn on the computer, you are not prompted for the power-on password. If you do not enter the password, the computer runs the CONFIG.SYS and AUTOEXEC.BAT instructions and starts the operating system, but the keyboard remains locked. If you have a PS/2 mouse, it also remains locked. If you enter the power-on password, the keyboard is unlocked, but the PS/2 mouse remains disabled. This mode is useful for network servers and other computers that operate unattended. If a power failure occurs, the computer automatically restarts and resumes operating in the Unattended Start mode when power is restored, without operator intervention.

Dual In the Dual mode, the startup behavior of the computer depends on whether the computer is started from the computer power switch or is started by an unattended method, such as a modem or timer. If you start the computer by using the power switch, you are prompted for the power-on password. Until the correct password is entered, the computer will not run the CONFIG.SYS or AUTOEXEC.BAT instructions, the operating system will not start, and the keyboard and PS/2 mouse will remain locked. If the computer is started by an unattended method, you are not prompted for the power-on password, and the computer is started in the Unattended Start mode.

Setting and Changing a Power-On Password: Use the Configuration/Setup Utility program to set or change a power-on password. You can use any combination of up to seven characters (A–Z, a–z, and 0–9) for your power-on password. Keep a record of your password in a secure place.

To set or change a power-on password:

1. Start the Configuration/Setup Utility program (see “Using the Configuration/Setup Utility Program” on page 16).
2. Select **System Security** from the Configuration/Setup Utility menu.
3. Select **Power-on Password**.
4. Type your password and press the down-arrow key.
5. Type your password again.
6. Select **Set or Change Power-on Password**.
7. At **Password Prompt**, select **On**, **Off**, or **Dual**.
8. Press **Enter**.
9. Remember to save the changes when you exit from the Configuration/Setup Utility program.

Additional Information for PS/2 Mouse Users

The following statement applies to only those who use a PS/2 mouse; a serial mouse is not affected by the Unattended Start mode.

The Unattended Start mode prevents the computer from detecting that a mouse is attached. Therefore, the mouse device driver will not be loaded automatically through the CONFIG.SYS or AUTOEXEC.BAT files when Unattended Start mode is enabled. You will have to load it later.

If you are using the OS/2 operating system, you must do *one* of the following before enabling the Unattended Start mode:

- Remove the mouse driver statement from the CONFIG.SYS file, or
- Set the CONFIG.SYS file so the operating system does not stop on a device-driver error. For example, use the PAUSEONERROR=NO statement.

Deleting a Power-On Password: Use the Configuration/Setup Utility program to delete a power-on password.

To delete a power-on password:

1. Start the Configuration/Setup Utility program (see “Using the Configuration/Setup Utility Program” on page 16).
2. Select **System Security** from the Configuration/Setup Utility menu.
3. Select **Power-on Password**.
4. Select **Delete Power-on Password**.
5. Press **Enter**.
6. Remember to save the changes when you exit from the Configuration/Setup Utility program.

Erasing an Unknown Power-On Password: To erase an unknown power-on password, you must remove the computer cover and move the password jumper on the system board. (See *Installing Options in Your Personal Computer* for more information.)

Use the Configuration/Setup Utility program to set a new password and reconfigure the computer.

Administrator Password

If you are responsible for maintaining the settings of several computers, you might decide to set an administrator password. Setting an administrator password deters unauthorized persons from changing settings in the Configuration/Setup Utility program. When an administrator password is set, a user can change

settings in the Configuration/Setup Utility program only after using that password. If the administrator password is not entered, the user can only view, not change, the settings.

When you set an administrator password, you have the option of specifying whether the user of the computer will be able to set and change power-on passwords on the computer.

The administrator password locks out access to the Configuration/Setup Utility program until the correct password is entered. When an administrator password is set, a password prompt appears each time you press **F1** to access the Configuration/Setup Utility program.

If a configuration error panel appears when you turn on the computer, the Configuration/Setup Utility program usually starts automatically, and the administrator password prompt appears on the screen. Before you can use the Configuration/Setup Utility program, you must type the correct password.

The password does not appear on the screen as you type it. If you type the wrong password, you receive a screen message telling you so. If you type the wrong password three times, you must turn off the computer and start again. When you type the correct password, the Configuration/Setup Utility program menu appears.

Setting and Changing an Administrator Password:

Use the Configuration/Setup Utility program to set or change an administrator password. You can use any

combination of up to seven characters (A–Z, a–z, and 0–9) for your power-on password. Keep a record of your password in a secure place.

For more information, refer to *Installing Options in Your Personal Computer*.

To set or change an administrator password:

1. Start the Configuration/Setup Utility program (see “Using the Configuration/Setup Utility Program” on page 16).
2. Select **System Security** from the Configuration/Setup Utility menu.
3. Select **Administrator Password**.
4. Type your password and press the down-arrow key.
5. Type your password again.
6. Select **Set or Change Administrator Password**.
7. At **Power-on password changeable by user**, select **Yes** or **No**.
8. Press **Enter**.
9. Remember to save the changes when you exit from the Configuration/Setup Utility program.

Deleting an Administrator Password: Use the Configuration/Setup Utility program to delete an administrator password.

To delete an administrator password:

1. Start the Configuration/Setup Utility program (see “Using the Configuration/Setup Utility Program” on page 16).
2. Select **System Security** from the Configuration/Setup Utility menu.

3. Select **Administrator Password**.
4. Select **Delete Administrator Password**.
5. Press **Enter**.
6. Remember to save the changes when you exit from the Configuration/Setup Utility program.

Erasing an Unknown Administrator Password: To erase an unknown administrator password, remove the computer cover and move the password jumper on the system board. For information on erasing an unknown password, See *Installing Options in Your Personal Computer*.

Use the Configuration/Setup Utility program to set a new password and reconfigure the computer.

Using Advanced Power Management

Your personal computer comes with built-in energy-saving capabilities. You can select energy-saving settings from the Configuration/Setup Utility program.

Advanced Power Management Features

With this option, you can have the computer, microprocessor, and monitor go into reduced-power states after a specified period of inactivity. Inactivity is determined by monitoring the interrupts listed in the Activity Monitor option in the Configuration/Setup Utility program. Interrupts for the keyboard, mouse, hard disk drive, serial ports, and parallel port are usually monitored for activity. You can specify up to three levels of power management, each one affecting system power,

microprocessor speed, and the monitor, if the monitor supports Display Power Management Signaling (DPMS).

Level-1 power management occurs after the shortest period of inactivity. You can specify Levels 2 and 3 if you want the power consumption to be reduced further after longer periods of inactivity. The following power-management options are available at each level:

- **System power:** If you select **Off**, the system power will be turned off after the specified period of inactivity. **Off** is then automatically selected for any subsequent levels.
- **Processor speed:** With this option, you specify a percentage reduction in microprocessor speed. At any subsequent levels, the microprocessor speed must be the same or it must be reduced further. Any activity on a monitored interrupt returns the microprocessor to full speed.
- **Display:** There are three reduced-power states for the monitor:
 - **Standby:** In this mode, the screen is blanked, but the screen image is restored immediately when any activity is detected.
 - **Suspend:** The monitor uses less power in this mode than in the Standby mode. The screen is blanked, but the screen image is restored within a few seconds after any activity is detected.
 - **Off:** In this mode, the monitor power is turned off. To restore power to the monitor, you must press the power switch on the monitor. On some

monitors, you might have to press the power switch twice.

Attention

If a device, such as a monitor, does not have power-management capabilities, it can be damaged when exposed to a reduced-power state.

Before you make energy-saving selections for your monitor, check the documentation that comes with your monitor to see if it supports Display Power Management Signaling (DPMS).

With the Hard File option, you can enable the hard disk drive to “spin down” (a shutdown of the drive motor) after about 20 minutes of inactivity on the drive. When you attempt to read from or write to the disk, full power is returned to the hard disk drive within a few seconds.

Setting Advanced Power Management Features

To set advanced power management features:

1. Start the Configuration/Setup Utility program (see “Using the Configuration/Setup Utility Program” on page 16).
2. Select **Advanced Power Management** from the Configuration/Setup Utility menu.
3. Be sure **APM BIOS Mode** is set to **Enabled**.
4. Select **Automatic Hardware Power Management**.
5. Set **Automatic Hardware Power Management** to **Enabled**.

6. Select values for the three levels of power management, as necessary.
7. Set **Hard File** to **Enabled** or **Disabled**.
8. Press **Enter**.
9. Remember to save the changes when you exit from the Configuration/Setup Utility program.

Using System Management

The Automatic Power-On options within the Advanced Power Management menu allow you to enable and disable features that turn your personal computer on automatically.

Wake Up on Ring

When this option is enabled, the computer is turned on automatically when a ring is detected on a modem. Two options control this feature:

- **Serial Port Ring Detect:** Set this option to **Enabled** if your personal computer has an external modem connected to the serial port.
- **Modem Ring Detect:** Set this option to **Enabled** if your personal computer has an internal modem.

Wake Up on Alarm

With this option, you can specify a date and time at which the computer will be turned on automatically. This can be either a single event or a daily event.

LAN Wake-Up

When this option is enabled, the computer is turned on when it receives a specific signal from another computer on a local area network (LAN). The computer must have a network adapter that supports wake-up requests and is configured properly.

Setting System Management Features

To set system management features:

1. Start the Configuration/Setup Utility program (see “Using the Configuration/Setup Utility Program” on page 16).
2. Select **Advanced Power Management** from the Configuration/Setup Utility menu.
3. Select **Automatic Power On**.
4. Select the option you want to set, and set or change the settings.
5. Press **Enter**.
6. Remember to save the changes when you exit from the Configuration/Setup Utility program.

Changing Keyboard Speed

You can change the speed at which the keyboard responds when you hold down a key. The normal *typematic rate* is 10 characters per second, but you can use the Configuration/Setup Utility program to increase this rate to 30 characters per second.

To change the keyboard speed:

1. Start the Configuration/Setup Utility program (see “Using the Configuration/Setup Utility Program” on page 16).
2. Select **Start Options** from the Configuration/Setup Utility menu.
3. Set **Keyboard Speed** to **Normal** or **Fast**.
4. Press **Enter**.
5. Remember to save the changes when you exit from the Configuration/Setup Utility program.

Changing Monitor Settings

To get the best possible image on your screen and reduce or eliminate flicker, you might need to reset the *resolution* (also called *addressability*) and *refresh rate* of your monitor.

Resolution is a measure of sharpness of the image on the screen, expressed as the number of picture elements, or pels (for example, 800 x 600). At higher resolutions, the monitor can show detailed images more clearly.

The refresh rate is the number of times per second that the electron beam scans from the top to the bottom of the screen; the refresh rate is expressed in hertz, or frequency in cycles per second (for example, 72 Hz).

A refresh rate can be interlaced or noninterlaced. With an interlaced refresh rate, the screen is divided into odd and even scan lines. In one pass, the electron beam refreshes the odd lines; in the next pass, it refreshes the even lines. With a noninterlaced refresh rate, every line is refreshed on each pass.

Tip

To minimize screen flicker and jitter, set your monitor for the highest noninterlaced refresh rate that it supports.

If your monitor complies with the VESA Display Data Channel (DDC) standard, it is probably already set to the highest refresh rate that the monitor and video controller can support. For more information about DDC, see *Understanding Your Personal Computer*.

You can easily change the settings for your monitor. But before you make changes, be sure to review the information that comes with your monitor. It should include the resolutions and refresh rates that your monitor supports. Refer to your operating-system documentation for information about changing the resolution.

Attention

Using a resolution or refresh rate that is not supported by your monitor can damage it. Refer to the information that comes with your monitor, or contact the manufacturer of the monitor for further information.

You can change these settings using the Configuration/Setup Utility program or other utility program.

To change the monitor settings:

1. Start the Configuration/Setup Utility program (see “Using the Configuration/Setup Utility Program” on page 16).
2. Select **Devices and I/O Ports** from the Configuration/Setup Utility menu.
3. Select **Video Setup...**

If your monitor is DDC compliant and **DDC Monitor checking** is set to **Enabled**, your monitor type might already be shown in the **Video Display Type** field. In this case, the monitor has already provided the computer with information about its refresh-rate capabilities, and you do not need to change the monitor settings. If your monitor is not DDC compliant, set **Video Display Type** to **Custom**, and continue to the next step.

4. For the resolution your monitor is using, select a refresh rate that is supported by the monitor. To minimize flicker and jitter, select the highest noninterlaced refresh rate available for the resolution your monitor is using. Within the parameters of the refresh rates and resolutions supported by your monitor, you might want to experiment to find which resolution produces the best image.
5. Press **Enter**.
6. Remember to save the changes when you exit from the Configuration/Setup Utility program.

Installing Video Device Drivers

Your personal computer comes with a S3 Trio64V+ video controller.

To take full advantage of this video controller, some application programs require custom software, known as video device drivers. The operating system loads these programs after the hardware is configured.

Important

If software was preinstalled on your hard disk, the video device drivers are already installed.

If software was *not* preinstalled on your hard disk, you must install the necessary video device drivers. Be sure to use only S3 Trio64V+ video drivers.

If you have an optional graphics adapter installed in your computer, refer to the documentation provided with the adapter for information about installing and updating video device drivers.

Regardless of whether video device drivers were preinstalled, in certain situations you might need to install them yourself, for example, to update existing drivers, to add drivers for certain software programs, or to reinstall software after formatting or adding a hard disk drive.

If software was preinstalled in your personal computer, see *About Your Software* for video device driver information.

If software was not preinstalled in your personal computer, video device drivers are available on CD-ROM or diskettes that come with your personal computer. Installation instructions are provided with the media or in the README files on the diskettes. Technical notes and explanations of some video device driver features might also be included in README files located in the directories that contain the video device drivers.

If your system has OS/2 preinstalled, see the documentation for that operating system for further information about video device drivers.

Many application programs include video device drivers that are compatible with the S3 Trio64V+ video controller.

If a customized video device driver is not included in your application package, select an SVGA- or VESA-compatible driver from those supplied by the manufacturer.

Adding Memory Modules

The main memory in your personal computer uses memory modules for temporary storage of data and instructions. These modules are also known as *single in-line memory modules (SIMMs)* and *dual in-line memory modules (DIMMs)*. On the system board, there are four SIMM sockets and one DIMM socket where you can install extra memory modules. The SIMMs and DIMMs that come standard with your personal computer are 60 nanosecond (ns) non-parity modules.

Note: For more information on adding memory modules, see *Installing Options in Your Personal Computer*.

Updating System Programs

The system programs include the power-on self-test (POST) and the basic input/output system (BIOS) code. A module called *electrically erasable programmable ROM (EEPROM)* (sometimes referred to as *flash memory*) has replaced the ROM module on the system board. It allows

you to easily update the BIOS and POST information from an update diskette.

As part of the on-going effort to improve quality, IBM occasionally makes enhancements to the POST routines and BIOS code. If updates are required, a diskette containing updated versions of the system programs will be made available. Complete instructions will be provided with the update diskette.

Diskettes

Your personal computer can use several types of diskettes. The information in this section will help you identify and use diskettes correctly. The following chart lists diskette drives and the diskettes they support.

Drive Type	Diskettes Supported
3.5-inch, 1.44 MB	1 MB and 2 MB
3.5-inch, 2.88 MB	1 MB, 2 MB, and 4 MB
5.25-inch, 1.2 MB	180 KB, 360 KB, and 1.2 MB

Notes:

1. 2.88 MB media might not be supported by certain operating systems.
2. If a 1.2 MB drive writes to a 180 KB or 360 KB diskette, that diskette might not be usable in a 360 KB drive.

Identifying Diskettes

The 5.25-inch diskettes have few physical characteristics to distinguish a 1.2 MB diskette from a 360 KB diskette. However, the 360 KB diskette generally has a white band

around the center hole. Otherwise, you must rely on the manufacturer's labels. The 1.2 MB diskettes usually are called *high density (HD)*; 360 KB diskettes usually are called *double sided/double density (DS/DD)*. If the diskettes come with plain labels, you might want to mark the capacity on each label.

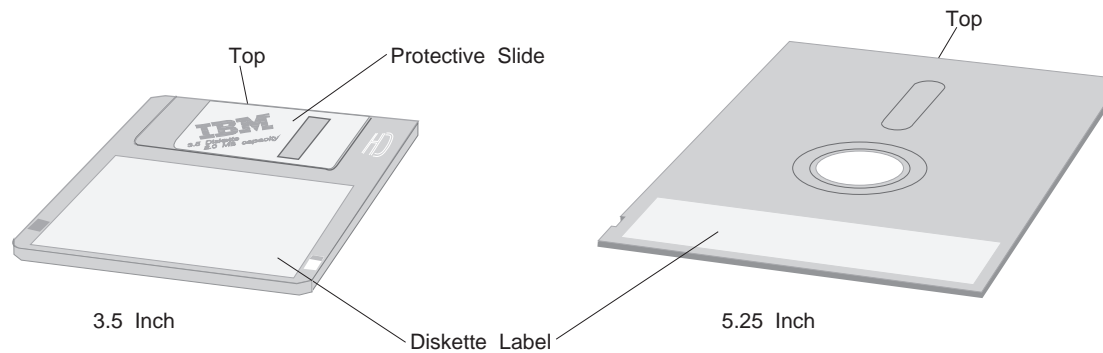

The 3.5-inch diskettes are not consistently identified by all diskette manufacturers. Some diskettes are labeled with the letters *HC*, *HD*, or *ED* to identify the diskette type; other diskettes might not be labeled. However, there is one physical characteristic that you can always use to identify the type of 3.5-inch diskette: Look for a cutout window at the lower-right corner of the diskette.

The following illustrations identify types of 3.5-inch diskettes.

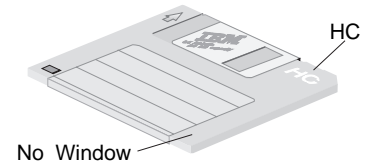

1 MB High Capacity (HC)

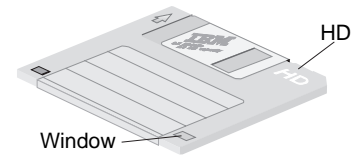

2 MB High Density (HD)

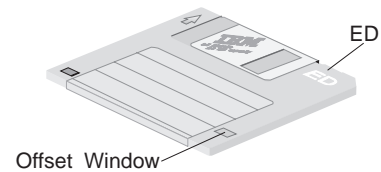

4 MB Extra-High Density (ED)

Handling and Storing Diskettes

Inside the protective diskette case is a flexible disk with a magnetic-sensitive coating. This disk can be damaged by heat, dust, a magnetic field, or even a fingerprint. Use the following guidelines when handling and storing diskettes:

- Data is stored on the magnetic surface of the diskette. On 3.5-inch diskettes, this surface is protected by a plastic cover. If the cover is damaged, *do not* use the diskette, because it could cause permanent damage to the diskette drive.
- A protective slide on the top of a 3.5-inch diskette covers part of the magnetic surface. The diskette drive moves this slide to read data from or write data to the diskette. *Do not* move this slide, because fingerprints and dust can cause loss of data.
- Keep 5.25-inch diskettes in their covers when you are not using them. The covers protect the exposed surfaces on the diskettes.
- Never touch the disk itself.
- Keep diskettes away from magnets or devices that create a strong magnetic field, such as electric motors and generators. Diskettes are sensitive to magnets found in television sets, stereo speakers, and other such items. A magnetic field can erase the data on your diskettes. *Do not* set diskettes on the monitor or use magnets to attach notes to your personal computer.
- Do not store diskettes in high temperatures, low temperatures, or direct sunlight. Temperatures ranging from 10° C to 52° C (50° F to 125° F) are acceptable for 5.25-inch diskettes, and 4° C to 53° C (39° F to 127° F) are acceptable for 3.5-inch diskettes. Keep diskettes away from heat. The plastic outer covering might warp, damaging the diskette.

Labeling Diskettes

Before using a diskette, label it so that you can identify the data stored on it. Labels usually come in the package with the diskettes. Diskette labels can become a problem if you do not apply them correctly. Loose edges or an excessive buildup of labels can prevent the diskette from being inserted or ejected.

To prevent this problem, take the following precautions:

- Remove an old label before you apply a new one.
- Apply labels carefully to ensure all edges are secure.
- Apply labels only to the front of diskettes. Do not place a label where it interferes with the protective slide or covers an opening in the protective diskette case.
- Use only a soft, felt-tip pen to write on the label. Using a pencil or ballpoint pen can damage a diskette.

Inserting and Removing Diskettes

3.5-Inch Diskette: To insert a 3.5-inch diskette, hold the diskette with the label facing up and insert the end with the protective slide first. Push the diskette into the 3.5-inch diskette drive until the diskette clicks into place.

To remove a 3.5-inch diskette, press the eject button and slide the diskette out of the drive. Do not remove a diskette while the in-use light is on.

5.25-Inch Diskette: To insert a 5.25-inch diskette, hold the diskette with the label facing up and your thumb on the label. Then slide the diskette fully into the 5.25-inch diskette drive until the diskette clicks into place.

To remove a 5.25-inch diskette, press the eject button and slide the diskette out of the drive. Do not remove a diskette while the in-use light is on.

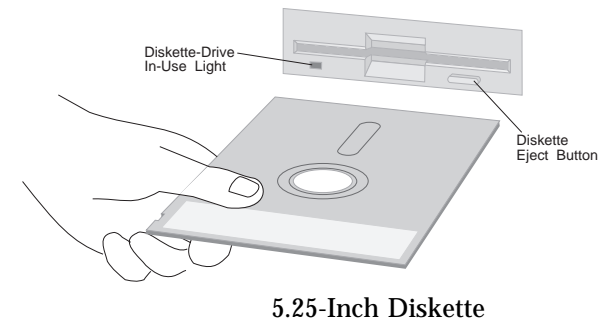
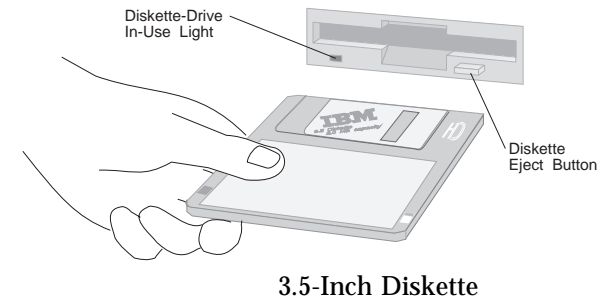

Write-Protecting Diskettes

It is possible to accidentally format a diskette or unintentionally write data to a diskette. Important information can be written over or lost. For this reason, you should write-protect important diskettes. You can read data from a write-protected diskette, but you cannot erase or change the data.

Most diskettes have a write-protect switch or notch that can be used to prevent data from being written to or erased from the diskette. If a diskette does not have a write-protect switch or notch, it is permanently write-protected.

The 3.5-inch diskette has a write-protect switch on the back.

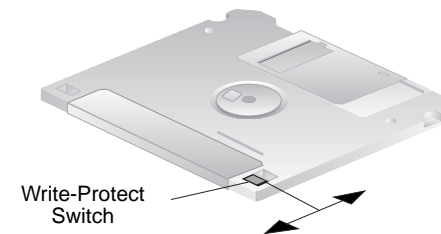

- To allow writing to the diskette, slide the switch so the write-protect window is covered.
- To prevent writing to the diskette, slide the switch so the write-protect window is open.

The 5.25-inch diskette has a write-protect notch on the side of the diskette. When you cover the notch with a write-protect tab or a piece of tape, it is write-protected.

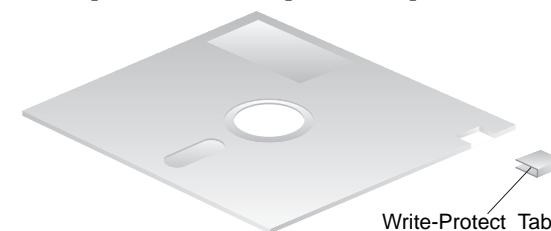

Formatting Diskettes

You can buy diskettes either formatted or unformatted. Formatted diskettes are ready to use; unformatted diskettes must be formatted by your operating system before you can use them. The format operation checks the diskette for defects and prepares it for storing data. If data is already stored on a diskette, the format operation writes over it, and the data is lost.

The operating-system `FORMAT` command specifies how to format a specific type of diskette. Always format diskettes to their correct capacity. Failing to do so could cause unreliable results. Differences such as magnetic coatings, the thickness of the diskette material, and the recording technique used all affect the formatting operation. Refer to your operating-system documentation for detailed information about formatting diskettes.

Note: If you are using DOS and have a 3.5-inch diskette formatted to an incorrect capacity, use the `FORMAT A:/U` command to format the diskette to the correct capacity. The standard `FORMAT A:` command might continue to format the diskette to the incorrect capacity.

If you plan to share diskettes with other people, you must know what types of diskette drives they have in their computers. The following table shows diskette types, their formatted capacity, and the drives that can use each diskette.

Diskette Type	Formatted Capacity	Drive Type
3.5-inch:		
1 MB (HC)	720 KB	1.44 MB or 2.88 MB
2 MB (HD)	1.44 MB	1.44 MB or 2.88 MB
4 MB (ED)	2.88 MB	2.88 MB
5.25-inch:		
360 KB (DS/DD)	360 KB	360 KB or 1.2 MB
1.2 MB (HD)	1.2 MB	1.2 MB

Notes:

1. Use `FORMAT A:/F:720` to format a 1 MB diskette in a 1.44 MB or 2.88 MB drive.
2. Use `FORMAT A:/F:1.44` to format a 2 MB diskette in a 2.88 MB drive.
3. When a 1.2 MB drive writes to a 360 KB diskette, the diskette might not be usable in a 360 KB drive.

Copying Diskettes

You can copy one or more files to or from a diskette, using the `COPY` command. Groups of files can be copied faster using the `XCOPY` command. Both `COPY` and `XCOPY` can copy files to different types of diskettes. For duplicating a diskette, use the `DISKCOPY` command. `DISKCOPY` requires that both the source diskette (the diskette you copy from) and the target diskette (the diskette you copy to) be the same type. Refer to your operating-system documentation for more information.

Using a CD-ROM Drive

If your personal computer comes with a compact disc-read only memory (CD-ROM) drive, or if you have added one, you are ready to enjoy the benefits of its huge storage capacity and versatility. A compact disc can store more than 650 MB of data, such as the huge files needed for audio, still and full-motion video, and still and animated graphics.

Follow these guidelines when using a CD-ROM drive:

- Do not place the drive where there is:
 - High temperature
 - High humidity
 - Excessive dust
 - Excessive vibration or sudden shock
 - An inclined surface
 - Direct sunlight
- Do not insert any object other than a compact disc into the drive.
- Before moving the computer, remove the compact disc from the drive.

Caution

If you use an optional floor stand to set your computer with CD-ROM in a vertical position, turn it so that the computer rests on its left side, as you face it.

Handling Compact Discs

When handling compact discs, follow these guidelines:

- Hold the compact disc by its edges. Do not touch the surface.
- To remove dust or fingerprints, wipe the compact disc from the center to the outside.
- Do not write on the surface.
- Do not store or place the compact disc in direct sunlight.
- Do not use benzene, thinners, or other cleaners to clean the compact disc.
- Do not bend the compact disc.

Attention

Wiping the compact disc in a circular direction can cause loss of data.

Loading a Compact Disc

To load a compact disc into the CD-ROM drive:

1. Press the Eject/Load button. The tray slides out of the drive.
2. Place the compact disc in the tray with the label facing up.
3. Close the tray by pressing the Eject/Load button, or by gently pushing the tray forward.

Attention

When loading a CD, do not manually force the tray open.

For further information, refer to the publication for your CD-ROM drive.

Using Locks

To deter unauthorized use of your personal computer, you can lock the cover, sliding door, and keyboard.

Locking the Cover and Sliding Door

You can use the cover lock and keys to secure the outside cover and the sliding door on the front panel. You can lock both the sliding door and the computer cover, the cover only, or neither. If the sliding door is closed when you lock the cover, the sliding door is locked.

Attention

If the sliding door is open when you lock the cover, the sliding door is *not* locked.

If you lock the cover without locking the sliding door, and then you want to lock the door also, do the following:

1. Unlock the cover.
2. Close the sliding door.
3. Lock the cover again, thus locking the sliding door also.

If a PCMCIA connector is installed in the front of your personal computer, you can lock it when you lock the cover and the sliding door. Be sure the small cover panel for the PCMCIA connector is in place; then lock the sliding door. When the PCMCIA connector is locked, you can slide its cover panel only halfway to the right.

Two identical keys are provided with your personal computer. Locksmiths are not authorized to duplicate these keys. You must order replacement keys from the key manufacturer. The key serial number and manufacturer's address are on a tag attached to the keys. You might want to record this information in the place provided in Appendix A, "Computer Records" on page 69. Store the tag in a safe place.

Locking the Keyboard

You can disable the keyboard so that others are unable to use it.

If a power-on password is set, the keyboard is locked when you turn on the computer. You must type the correct password before you can type anything else.

You can enable the power-on password feature with the Configuration/Setup Utility program. See “Setting and Changing a Power-On Password” on page 19.

Some operating systems have a keyboard and mouse lock-up feature. Check the documentation that comes with your operating system for more information.

Chapter 4. Taking Care of Your Personal Computer

This chapter guides you in proper handling and care of your computer equipment.

Basics

Here are some basic points about keeping your computer functioning properly:

- Keep your computer in a clean, dry environment. Make sure it rests on a flat, sturdy surface.
- Do not place items on top of the display or cover any of the vents in the monitor or computer. These vents provide air flow to keep your computer from overheating.
- Keep food and drinks away from all parts of your computer. Food particles and spills will make the keyboard and mouse sticky and unusable.
- Do not get the power switches or other controls wet. Moisture can damage these parts and cause an electrical hazard.
- Always disconnect a power cord by grasping the plug, not the cord.

Cleaning Your Personal Computer

It is good practice to clean your computer periodically to protect the surfaces and ensure trouble-free operation.

Computer and Keyboard

Use only mild cleaning solutions and a damp cloth to clean the painted surfaces of the computer.

Monitor Screen

Do not use abrasive cleaners when cleaning the surface of the monitor screen. The screen surface is easily scratched, so avoid touching it with pens, pencil points, and erasers.

To clean the screen surface, wipe it gently with a soft, dry cloth, or blow on the screen to remove grit and other loose particles. Then use a soft cloth moistened with a nonabrasive liquid glass cleaner.

Mouse

If the pointer on the monitor does not move smoothly with the mouse, you might need to clean the mouse:

1. Turn the computer off.
2. Disconnect the mouse cable from the computer.
3. Turn the mouse upside down. Unlock the retainer on the bottom of the mouse by moving it in the direction indicated by the arrow on the retainer.

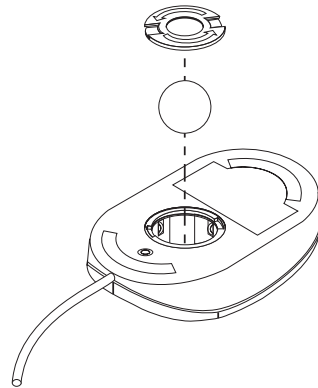

4. Turn the mouse right-side up, and the retainer and ball will drop out.
5. Wash the ball in warm, soapy water, and dry it well.
6. Using a damp cloth, wipe the outside of the mouse and the retainer. Be sure to wipe the rollers inside the mouse.

7. Insert the ball and retainer. Lock the retainer by moving it in the opposite direction of the arrow.
8. Reconnect the mouse cable to the computer.

Replacing the Battery

Your computer has a special type of memory that maintains the date, time, and the settings for built-in features, such as serial- and parallel-port assignments (configuration). A battery keeps this information active when you turn off the computer.

The battery requires no charging or maintenance throughout its life; however, no battery lasts forever. If the battery fails, the date, time, and configuration information (including passwords) are lost. An error message is displayed when you turn on the computer.

Refer to *Installing Options in Your Personal Computer* for information about replacing the battery.

If you replace the original lithium battery with a heavy-metal battery or a battery with heavy-metal components, be aware of the following environmental consideration: Batteries and accumulators that contain heavy metals must not be disposed of with normal domestic waste. They will be taken back free of charge by the manufacturer, distributor, or representative to be recycled or disposed of in a proper manner.

Moving Your Personal Computer

Normal shipping and handling can cause loss of data from a hard disk. If your computer has a hard disk drive, take the following precautions:

1. Back up all files and data from the hard disk.

Operating systems can vary in the way they perform backup procedures. Some operating systems save only data files, while others make copies of application program files *and* data files. Refer to your operating system documentation for information about software backup.

2. Remove all media (diskettes, compact discs, tapes, and so on) from the drives.
3. Turn off the computer and all attached devices. Your hard disk drive automatically parks the read/write

heads in a nondata area. This process prevents damage to the hard disk.

4. Unplug the power cords from electrical outlets.
5. Note where you have attached your cables to the rear of the computer; then remove them.

Caution

Do not risk injury by moving or lifting the computer by yourself. Ask another person to help you.

If you saved the original shipping cartons and packing materials, use them to pack the units. If you are using different cartons, cushion the units to avoid any damage.

Pack the computer and all devices. Cushion them well on the sides, top, and bottom to avoid damage.

Chapter 5. Solving Problems

This chapter presents an overview of diagnostic tools available to you. You can use these tools to identify and correct problems that come up as you use your personal computer. This chapter also contains information about terminate-and-stay-resident and a section on how to get help, service, and additional information.

Using Diagnostic Tools

Computer problems can be caused by hardware, software, or a user error (for example, pressing the wrong key). Using the diagnostic aids discussed in this chapter, you might be able to solve problems yourself or gather helpful information you can pass on to a service technician.

You can check the hardware by following the procedures in this chapter and using the diagnostic programs preinstalled in your computer.

Caution

Be careful when moving or changing the position of the computer, monitor, or other components. Do not attempt to lift any object that you think might be too heavy for you.

If the hardware checks out OK, and you have not made a user error, you might have a software problem. If you suspect that you have a software problem, refer to the information that comes with the software package.

The following tools are available to diagnose hardware-related problems:

- Power-on self-test (POST)
- POST beep codes messages
- Diagnostic programs
- Error messages
- Troubleshooting charts
- Option diskettes

Descriptions of these tools follow.

Power-On Self-Test (POST)

Each time you turn on the computer, it performs a series of tests that check the operation of the base computer. This series of tests is called the *power-on self-test* or *POST*.

POST does the following:

- Checks basic system-board operations
- Checks the memory operation
- Compares the current system configuration with that established by the Configuration/Setup Utility program
- Starts the video operation
- Verifies that the diskette drive is working
- Verifies that the hard disk drive is working

While the memory is tested, numbers indicating the amount of memory appear in the top-left corner of your screen. The Configuration/Setup Utility program symbol appears in the top-right corner of your screen, and the

Configuration/Setup Utility program prompt appears in the bottom-left corner of your screen.

Tip

Note: The amount of available memory shown might be somewhat less than expected because of basic input/output system (BIOS) shadowing in random access memory (RAM).

If POST finishes without detecting any problems, a single beep sounds. Then the first screen of your operating system or application program appears.

If POST detects a problem, an error message appears on your screen. A single problem can cause several error messages to appear. When you correct the cause of the first error message, the other error messages probably will not appear on the screen the next time you turn on the system.

POST Beep Codes

POST generates a beeping sound to indicate successful completion of POST or to indicate that the tests detect an error.

One beep and the appearance of text on the display indicates successful completion of POST. More than one beep indicates that POST detects an error.

Tip

If your computer does not start when you press the power switch, try the following:

- Make sure all cables are securely connected to the correct locations.
- Check to see if the voltage-selection switch is set to the correct position.

If the problem is not corrected, have your computer serviced.

Diagnostic Programs

IBM provides programs for diagnosing software and hardware problems.

QAPlus/WIN-WIN

QAPlus/WIN-WIN, a Windows program, is included in preinstalled software. QAPlus/WIN-WIN provides an effective tool for isolating software-related problems, because it encompasses the entire operating system. QAPlus/WIN-WIN gathers Windows-related information and also does some hardware device testing.

QAPlus/PRO

QAPlus/PRO is a DOS diagnostic program that is available to you either in preinstalled software or on a diskette.

If your computer has DOS or DOS with Windows preinstalled, you access QAPLus/PRO by entering QAPRO at the C:\ prompt. (If you are using Windows when you want to use QAPLus/PRO, first exit from Windows, and then enter QAPRO at the C:\ prompt.)

QAPLus/PRO provides similar diagnostic capacity to QAPLus/WIN-WIN, but it is more balanced between software and hardware problem determination. The Windows-related information that is available in QAPLus/WIN-WIN is not available in QAPLus/PRO. However, QAPLus/PRO does gather a wealth of information about the DOS environment, including device drivers. It more effectively isolates hardware problems than QAPLus/WIN-WIN, because it is not limited by the operating system environment.

When OS/2 is preinstalled, QAPLus/PRO is not available from the hard disk. However, you can use the Diskette Factory to build the QAPLus/PRO diskette.

If software was not preinstalled in your computer, QAPLus/PRO is provided on a diskette that comes with your computer. You access QAPLus/PRO by starting your computer with the QAPLus/PRO diskette in the first diskette drive.

Using QAPLus/PRO from a diskette provides the greatest amount of hardware testing and the least amount of software problem determination. All customization is excluded from this testing, including device drivers that were preinstalled or have been added and terminate-and-stay-resident programs, so that a clean environment is presented to the testing tool.

This method of testing is generally used when other methods are not accessible or have not been successful in isolating a problem suspected to be hardware related.

CoSession for Windows

If the CoSession for Windows program is preinstalled in your computer, an IBM HelpWare support person can use that program to diagnose your system from a remote location. To use CoSession for Windows, you must have a modem attached to your computer.

Tip

Contact IBM HelpWare before attempting to use CoSession for Windows. HelpWare support will provide specific instructions for setting up and using this program.

Error Messages

Error messages that appear on the screen might be text, numeric, or both. There are three types of error messages:

- POST error messages

Messages that appear when POST finds problems with the hardware during start-up or when a change in the hardware configuration is found. POST error messages are 3-, 4-, 5-, 8-, or 12-character alphanumeric messages and include brief explanations.

For more information about what caused the error message to appear and what action to take, refer to “POST Messages” on page 46.

- Diagnostic error messages

Messages that appear if a hardware problem is detected by a diagnostic test program. The messages present text information that can be used to identify a failing part.

- Software-generated error messages

Messages that appear if a problem or conflict is detected by the application program, the operating system, or both. Error messages for operating-system and software problems are generally text messages,

but they also can be numeric messages. For information about these software error messages, refer to the information that comes with the operating system or application program, or both.

POST Messages

The computer might display more than one error message. Often, the first error to occur causes subsequent errors. Always follow the suggested action for the *first* error message that appears.

In the following table, “X” can be any alphanumeric character.

POST Message	Description
101 102	A failure occurred during testing of the system board and microprocessor. <i>Action:</i> Have the system unit serviced.
110	A memory parity failure occurred during testing of the system board. <i>Action:</i> Run the diagnostic tests to verify that a problem exists in the memory-module kits. See the system memory table in <i>Installing Options in Your Personal Computer</i> to see if you can reconfigure (swap) your system memory to aid in identifying the defective memory module. If you cannot identify the defective memory module in this way, have the computer serviced.
114	An adapter read-only memory (ROM) error occurred. <i>Action:</i> If you can start the computer without the adapters installed, remove all option adapters, reinstall them one at a time, and retest after reinstalling each one. When an adapter causes a failure, replace it. If the problem cannot be isolated and corrected, have the system unit serviced.
121	A hardware error occurred. <i>Action:</i> Have the computer serviced.
161	The battery on the system board is dead. CAUTION: Danger of explosion if lithium battery is incorrectly replaced. Replace the battery with the same or equivalent type recommended by the manufacturer. Dispose of batteries as required by local ordinances or regulations. <i>Action:</i> Until you replace the battery, the computer can be used. However, you will have to run the Configuration/Setup Utility program and set the time and date each time the computer is turned on. (See <i>Installing Options in Your Personal Computer</i> for additional instructions.)

POST Message	Description
162	<p>A change in device configuration occurred. This error occurs under one or more of the following conditions:</p> <ul style="list-style-type: none"> • A new device has been installed. • A device has been moved to a different location or cable connection. • A device has been removed or disconnected from a cable. • A device is failing and is no longer recognized by the computer as being installed. • An external device is not turned on. • An invalid checksum is detected in the battery-backed memory. <p><i>Action:</i> Verify that all external devices are turned on. External devices must be turned on before the computer is turned on.</p> <p>If you did not add, remove, or change the location of a device, a device is probably failing. Running the diagnostic programs might isolate the failing device, but you must have the computer serviced.</p>
163	<p>The clock is not working correctly.</p> <p><i>Action:</i> Set the correct date and time. If the date and time are set correctly and saved and the 163 error message reappears, replace the battery.</p> <p>If this does not correct the problem, have the computer serviced.</p> <p>Until the computer is serviced, it can be used, but any application programs that use the date and time will be affected.</p>
164	<p>A change in the memory configuration occurred. This error can be caused by adding memory, removing memory, or incorrectly installing memory.</p> <p><i>Note:</i> The computer can be used with decreased memory capacity.</p> <p><i>Action:</i></p> <ol style="list-style-type: none"> 1. If you have newly installed memory, see <i>Installing Options in Your Personal Computer</i> to verify that the new memory is correct for your computer and that the memory module configuration matches one of the configurations shown in the system memory table. 2. Running the diagnostic tests might isolate the location of the problem memory-module kit and provide additional information. 3. If the system diagnostic tests detect a failure, have the computer serviced.

POST Message	Description
20X	<p>A failure occurred during testing of the memory. This error can be caused by incorrectly installed memory, a failing memory-module kit, or a system-board failure.</p> <p><i>Action:</i></p> <ol style="list-style-type: none"> 1. If you just installed memory, see <i>Installing Options in Your Personal Computer</i> to verify that the new memory is correct for your system unit, that it is installed correctly, and that the memory-module configuration matches one of the configurations shown in the system memory table. 2. Run the diagnostic tests to verify the problem. 3. If the system diagnostic tests detect a failure, have the computer serviced.
229	<p>An external cache error occurred.</p> <p><i>Action:</i> Have the computer serviced.</p>
301 303	<p>A failure occurred during testing of the keyboard and keyboard controller. These error messages also might be accompanied by continuous beeping.</p> <p><i>Action:</i></p> <p>Ensure that:</p> <ol style="list-style-type: none"> 1. Nothing is resting on the keyboard and pressing a key 2. No key is stuck 3. The keyboard cable is connected correctly to the keyboard and to the correct connector on the computer. <p>Running the diagnostic tests can isolate the computer component that failed, but you must have your computer serviced.</p> <p><i>Note:</i> If you have just connected a new mouse or other pointing device, turn the computer off and disconnect that device. Wait at least 5 seconds, and then turn the computer on. If the error message goes away, replace the device.</p> <p>If the error message remains, have the keyboard and cable or the computer serviced.</p>
601	<p>A failure occurred during testing of the diskette drive and diskette-drive controller. This error can be caused by a loose or incorrectly connected cable, a failing drive, or a failing system board.</p> <p><i>Action:</i> The computer can be used, but one or more diskette drives might not work. Running the diagnostic tests can isolate the diskette drive that failed, but you must have your computer serviced.</p>

POST Message	Description
602	<p>The computer is not able to start the diskette in the drive. The diskette might be damaged or formatted incorrectly.</p> <p><i>Action:</i> Try another startable diskette that is in working condition.</p>
604	<p>A failure occurred during the testing of a diskette drive.</p> <p><i>Action:</i></p> <ol style="list-style-type: none"> 1. Verify that the Configuration/Setup Utility program correctly reflects the type of diskette drive you have installed. 2. Run the system diagnostic programs. 3. If the system diagnostic programs detect a failure, replace the diskette drive.
178X	<p>A failure occurred during testing of the hard disk drive or a primary or secondary IDE device.</p> <p><i>Action:</i> Run the system diagnostic tests.</p>
1800	<p>A PCI adapter has requested a hardware interrupt that is not available.</p> <p><i>Action:</i></p> <ol style="list-style-type: none"> 1. Make sure the PCI adapter and any ISA legacy adapters are set correctly in the Configuration/Setup Utility program. If the interrupt resources settings are not correct, change the settings. Setting the resources used by ISA legacy adapters to Not available enables the Plug and Play function to configure around the legacy adapters. For instructions on using the Configuration/Setup Utility program, see "Configuring Your Personal Computer" on page 15. 2. If all interrupts are being used by ISA legacy adapters, you might need to remove one to make an interrupt available to the PCI adapter. For instructions on removing adapters, see <i>Installing Options in Your Personal Computer</i>.

POST Message	Description
1801	<p>A PCI adapter has requested memory resources that are not available.</p> <p><i>Action:</i></p> <ol style="list-style-type: none"> 1. Make sure the PCI adapter and any ISA legacy adapters are set correctly in the Configuration/Setup Utility program. If the memory resources settings are not correct, change the settings. Setting the resources used by ISA legacy adapters to Not available enables the Plug and Play function to configure around the legacy adapters. For instructions on using the Configuration/Setup Utility program, see “Configuring Your Personal Computer” on page 15. 2. If all memory resources are being used by ISA legacy adapters, you might need to remove one to make memory available to the PCI adapter. For instructions on removing adapters, see <i>Installing Options in Your Personal Computer</i>.
1802	<p>A PCI adapter has requested an I/O address that is not available, or the PCI adapter might be defective.</p> <p><i>Action:</i></p> <ol style="list-style-type: none"> 1. Make sure the PCI adapter and any ISA legacy adapters are set correctly in the Configuration/Setup Utility program. Setting the resources used by ISA legacy adapters to Not available enables the Plug and Play function to configure around the legacy adapters. 2. If the I/O port resources settings are correct, the PCI adapter might be defective. Have the computer serviced.
1803	<p>A PCI adapter has requested a memory address that is not available, or the PCI adapter might be defective.</p> <p><i>Action:</i></p> <ol style="list-style-type: none"> 1. Make sure that any ISA legacy adapters are set correctly in the Configuration/Setup Utility program. If the memory resources settings are not correct, change the settings. Setting the resources used by ISA legacy adapters to Not available enables the Plug and Play function to configure around the legacy adapters. For instructions on using the Configuration/Setup Utility program, see “Configuring Your Personal Computer” on page 15. 2. If the memory resources settings are correct, the PCI adapter might be defective. Have the computer serviced.

POST Message	Description
1804	<p>A PCI adapter has requested a memory address that is not available.</p> <p><i>Action:</i></p> <ol style="list-style-type: none"> 1. Make sure that any ISA legacy adapters are set correctly in the Configuration/Setup Utility program. If the memory resources settings are not correct, change the settings. Setting the resources used by ISA legacy adapters to Not available enables the Plug and Play function to configure around the legacy adapters. For instructions on using the Configuration/Setup Utility program, see “Configuring Your Personal Computer” on page 15. 2. If all memory addresses are being used by ISA legacy adapters, you might need to remove one to make memory addresses available to the PCI adapter. For instructions on removing adapters, see <i>Installing Options in Your Personal Computer</i>.
1805	<p>A PCI adapter read-only memory (ROM) error occurred.</p> <p><i>Action:</i> Remove all PCI adapters.</p> <p>If you can start the computer without the PCI adapters, reinstall each adapter, one at a time, and retest. When an adapter causes a failure, replace it.</p> <p>If the problem cannot be isolated and corrected, have the computer serviced.</p>
1962	<p>A boot sequence error occurred.</p> <p><i>Action:</i></p> <ol style="list-style-type: none"> 1. Make sure the adapter option is set correctly in the Configuration/Setup Utility program. If the setting is not correct, change the setting. For instructions on using the Configuration/Setup Utility program, see “Configuring Your Personal Computer” on page 15. 2. Make sure all adapters are installed correctly. For instructions on installing adapters, see <i>Installing Options in Your Personal Computer</i>.

POST Message	Description
2462	<p>A video configuration error occurred.</p> <p><i>Action:</i></p> <ol style="list-style-type: none"> 1. Make sure the display cables are correctly and securely connected to the system unit. 2. If you just added or removed video memory, use the Configuration/Setup Utility program to make sure the settings in Video Setup are correct. If the settings are not correct, change the settings. For instructions on using the Configuration/Setup Utility program, see “Configuring Your Personal Computer” on page 15. 3. If the error recurs, you might need to replace the video memory module. 4. If the error persists, have the computer serviced.
I9990301	<p>A hard disk failure occurred.</p> <p><i>Action:</i> Have the computer serviced.</p>
I9990305	<p>An operating system could not be found.</p> <p><i>Action:</i> Run diagnostic tests to verify that the hard disk drive is functioning correctly. If there is a problem with the hard disk (such as a bad sector), you might have to reinstall the operating system.</p> <p>If you cannot reinstall the operating system, have the computer serviced.</p>
Other Numbers	<p>The computer POST found an error.</p> <p><i>Action:</i> Follow the instructions on the screen.</p>

Troubleshooting Charts

You can use the troubleshooting charts in this section to find solutions to problems that have definite symptoms.

Tip

If you have just added new software or a new computer option and your computer is not working, do the following before using the troubleshooting charts:

- Remove the software or device you just added.
- Run the diagnostic test programs to determine if your computer is running correctly.
- Reinstall the new software or new device.

When using the troubleshooting charts, look for the symptom of the problem in the left column of the chart. You will find instructions and possible solutions to the problem in the right column of the chart.

Diskette Drive Problems**Action**

Diskette drive in-use light stays on, or the system bypasses the diskette drive.

If there is a diskette in the drive, verify that:

1. The diskette drive is enabled in the Configuration/Setup Utility program.
2. The diskette is good and not damaged. (Try another diskette if you have one.)
3. The diskette is inserted correctly (label up and metal-shutter end first) in the drive.
4. The diskette contains the necessary files to start the computer.
5. Your software program is OK (see **Software Problem** at the end of these troubleshooting charts).

If the diskette drive in-use light stays on, or the system continues to bypass the diskette drive, have the computer serviced.

Monitor Self-Tests**Action**

Some IBM monitors have their own self-tests. If you suspect a problem with your monitor, refer to the information supplied with the monitor for adjusting and testing instructions.

If you still cannot find the problem, have the monitor and computer serviced.

Monitor Problems	Action
Wavy, unreadable, rolling, distorted screen, or screen jitter.	<p>If the monitor self-tests show the monitor is OK, consider the location of the monitor. Magnetic fields around other devices (such as transformers, appliances, fluorescent lights, and other monitors) can cause screen jitter or wavy, unreadable, rolling, or distorted screen images. If this happens, turn off the monitor. (Moving a color monitor while it is turned on might cause screen discoloration.) Adjust the locations of the device and the monitor so that they are at least 305 mm (12 in.) apart. Turn the monitor on.</p> <p><i>Notes:</i></p> <ol style="list-style-type: none"> 1. The distance between monitors and diskette drives should be at least 76 mm (3 in.) to prevent diskette drive read/write errors. 2. Non-IBM monitor cables might cause unpredictable problems. 3. An enhanced monitor cable with additional shielding is available for Model 9521 and 9527 displays. See your IBM reseller or IBM marketing representative for information about the enhanced monitor cable. <p>If the problem recurs, have the monitor and computer serviced.</p>
Screen flickers.	<p>Set the monitor for the highest, noninterlaced refresh rate available.</p> <p>To reset the refresh rate, use a utility program such as the IBM Personal Computer Configuration/Setup Utility program. For OS/2, use Set Up Display in Easy Tools for OS/2.</p> <p>See "Monitors" in <i>Understanding Your Personal Computer</i> for more information about monitors.</p>
The monitor works when you turn on the system, but goes blank when you start some application programs.	<p>Verify that the primary monitor cable is connected to the video port.</p> <p>To find the video port, see <i>Setting Up Your Personal Computer</i>.</p> <p>Be sure you installed the necessary device drivers for the applications.</p>
Blank screen	<p>Verify that:</p> <ol style="list-style-type: none"> 1. The computer power cord is plugged into the computer and a working electrical outlet. 2. The monitor is turned on and the Brightness and Contrast controls are adjusted correctly. 3. The monitor signal cable is connected to the correct connector on the computer. <p>If the items above are correct and the screen remains blank, have the computer serviced.</p>

Monitor Problems	Action
Only the cursor appears.	Have the computer serviced.
Wrong characters appear on the screen.	Have the computer serviced.
General Problems	Action
Problems such as broken cover locks or indicator lights not working.	Have the computer serviced.
Intermittent Problems	Action
A problem occurs only occasionally and is difficult to detect.	<p>Verify that:</p> <ol style="list-style-type: none"> 1. All cables and cords are securely connected to the rear of the computer and attached options. 2. When the computer is turned on, air is flowing from the rear of the computer at the fan grille. If there is no air flow, the fan is not working. This causes the computer to overheat and shut down. 3. The last external device in each SCSI chain is terminated correctly. (See your SCSI documentation.) <p>If the items above are correct, have the computer serviced.</p>
Keyboard, Mouse, or Pointing-Device Problems	Action
All or some keys on the keyboard do not work.	<ol style="list-style-type: none"> 1. Make sure the keyboard cable is properly connected to the computer. 2. Make sure the computer and the monitor are turned on. <p>If the items above are correct, have the computer serviced.</p>

**Keyboard, Mouse,
or Pointing-
Device Problems****Action**

The mouse or pointing device does not work.

Verify that the mouse or pointing-device cable is securely connected and the device drivers are installed correctly.

If the problem recurs, have the computer and the device serviced.

Memory Problems**Action**

The amount of memory displayed is less than the amount of memory installed.

Review the tip concerning memory on page 44.

Verify that:

1. The memory modules are seated properly.
2. Memory modules are installed in pairs (when required).
3. If you changed the memory, you updated the memory configuration in the Configuration/Setup Utility program.

If the above items are correct, run the memory test program from the QAPlus/WIN-WIN diagnostic test program. The system might have detected a bad memory module and automatically reallocated memory to enable you to continue to operate. If the memory tests detect a failure, have the computer serviced.

“Not enough memory” message is displayed.

Verify that terminate-and-stay-resident (TSR) programs are not taking up memory. See “Managing TSR Programs” on page 62.

Option Problems	Action
An IBM option that was just installed does not work.	<p>Verify that:</p> <ol style="list-style-type: none"> 1. The option is designed for the computer. 2. You followed the installation instructions supplied with the option. See “Installing Files from Option Diskettes” on page 62 for information about installing option files. 3. The option is installed correctly. 4. You have not loosened any other installed options or cables. 5. You updated the configuration information in the Configuration/Setup Utility program. Whenever memory or an option is changed, you must update the configuration. <p>If you are using an expanded- or enhanced-memory manager, such as the DOS expanded memory specification (EMS) device driver, refer to “Memory” in <i>Understanding Your Personal Computer</i>.</p> <p><i>Note:</i> The Plug and Play feature uses memory addresses ED00h to EDFFh. If you use a memory-manager program or install an ISA legacy adapter, make sure that they do not use addresses within this address range.</p> <p>If all of the above items are correct, start QAPlus/WIN-WIN or QAPlus/PRO. If the test programs find no problem, have the computer and the option serviced.</p>
An IBM option that used to work does not work now.	<p>Verify that all of the option hardware and cable connections are secure.</p> <p>If the option comes with its own test instructions, use those instructions to test the option.</p> <p>If the items above are correct and the test programs found no problem, have the computer and option serviced.</p> <p>If the failing option is a SCSI option, verify that:</p> <ol style="list-style-type: none"> 1. The cables for all external SCSI options are connected correctly. 2. The last option in each SCSI chain, or the end of the SCSI cable, is terminated correctly. 3. All external SCSI options are turned on. External SCSI options must be turned on before the system is turned on. <p>For more information, see your SCSI documentation.</p> <p>If the problem recurs, have the computer serviced.</p>

Parallel Port Problems	Action
The number of parallel ports displayed is less than the number of parallel ports installed.	<p>Verify that:</p> <ol style="list-style-type: none"> 1. Each port is assigned a unique address. 2. The parallel-port adapter, if you installed one, is seated properly. <p>If the items above are correct, have the computer serviced.</p>
Serial Port Problems	Action
The number of serial ports displayed is less than the number of serial ports installed.	<p>Verify that:</p> <ol style="list-style-type: none"> 1. Each port is assigned a unique address. 2. The serial-port adapter, if you installed one, is seated properly. <p>If the items above are correct, have the computer serviced.</p>
Printer Problems	Action
The printer does not work.	<p>Verify that:</p> <ol style="list-style-type: none"> 1. The printer is turned on and is online. 2. The printer signal cable is connected to the correct serial or parallel port on the system. (For the location of the serial or parallel port, see <i>Setting Up Your Personal Computer</i>.) <p><i>Note:</i> Non-IBM printer cables might cause unpredictable problems.</p> <ol style="list-style-type: none"> 3. You have assigned the printer port correctly in your operating system or application program. 4. You have assigned the printer port correctly using the Configuration/Setup Utility program. <p>If the items above are correct and the printer still does not work, run the tests described in the manual that comes with your printer. If the tests show the printer is OK, have the computer serviced.</p>

Software Problem	Action
Is your software program OK?	<p data-bbox="829 448 1535 472">To determine if problems are caused by the software, verify that:</p> <ol data-bbox="842 493 1898 683" style="list-style-type: none"><li data-bbox="842 493 1898 550">1. Your system has the minimum memory requirements needed to use the software. Refer to the information supplied with the software to verify memory requirements.<li data-bbox="842 565 1944 589"><i>Note:</i> If you have just installed an adapter or memory, you might have a memory address conflict.<li data-bbox="842 597 1465 621">2. The software is designed to operate on your computer.<li data-bbox="842 630 1314 654">3. Other software works on your computer.<li data-bbox="842 662 1478 683">4. The software you are using works on another computer. <p data-bbox="829 699 1948 756">If you received any error messages when using the software program, refer to the information supplied with the software for a description of the messages and solutions to the problem.</p> <p data-bbox="829 773 1997 829">If the items above are correct and the problem remains, contact your place of purchase or service technician for help.</p>

Installing Files from Option Diskettes

An optional device or adapter might come with a diskette. Diskettes that are included in option packages usually contain files that the computer needs for recognizing and activating the options. Until you install the necessary files, the new device or adapter might cause error messages.

If your optional device or adapter came with a diskette, you might need to install some configuration (.CFG) files or diagnostic files (.EXE or .COM) from the diskette to your hard disk.

Managing TSR Programs

Terminate-and-stay-resident (TSR) programs are loaded into memory and stay there so you can access them whenever you want. If you are loading or using an application program and receive a message that you do not have enough memory, TSR programs might be taking up valuable space.

Check the documentation that comes with each TSR program to find out how to solve this problem. You might be able to remove the program from memory for the rest of your current work session. Sometimes you can change the order in which the TSR programs are loaded so that memory is used more efficiently. Or perhaps you can remove from the AUTOEXEC.BAT file the TSR programs that you do not use frequently.

See your operating system documentation for assistance on editing or disabling statements in the AUTOEXEC.BAT file.

Chapter 6. Getting Help, Service, and Information

If you need help, service, technical assistance, or just want more information about IBM products, you will find a wide variety of sources available from IBM to assist you. This section provides information about those sources.

Services available and telephone numbers listed are subject to change without notice.

Solving Problems

Many computer problems can be solved without outside assistance, by using the online help or by looking in the online or printed documentation that comes with your computer or software. Also, be sure to read the information in any README files that come with your software.

Most computers, operating systems, and application programs come with documentation that contains troubleshooting procedures and explanations of error messages. The documentation that comes with your computer also contains information about the diagnostic tests you can perform.

If you suspect a hardware problem, run the diagnostic tests and make a note of any error messages you receive. Then look up the message in the documentation and take the appropriate action.

If you suspect a software problem, consult the documentation (including README files) for the operating system or application program.

Using the HelpWare Support Family

IBM HelpWare is the solution for IBM PC service and support wherever IBM products are sold and serviced. Purchasing an IBM PC hardware product entitles you to standard help and support during the warranty period. If you need additional support and services, HelpWare provides a wide variety of extended services that address almost any need.

Using Electronic Support Services

If you have a modem, you can get help from several popular services. Bulletin boards and online information services provide assistance through question-and-answer message areas, live chat rooms, searchable databases, and more.

Technical information is available on a wide range of topics, such as:

- Hardware setup and configuration
- Preinstalled software
- OS/2, DOS, and Windows
- Networking
- Communications
- Multimedia

In addition, the latest device driver updates are available.

The IBM PC Company Bulletin Board System (BBS) can be reached 24 hours a day, 7 days a week. Modem speeds of up to 14 400 baud are supported. Long distance telephone charges might apply. To access the PC Company BBS:

- In the U.S., call 1-919-517-0001.
- In Canada:
 - In Halifax, call 902-420-0300.
 - In Montreal, call 514-938-3022.
 - In Toronto, call 905-316-4255 or 416-956-7877.
 - In Vancouver, call 604-664-6461 or 604-664-6464.
 - In Winnipeg, call 204-934-2735.

Commercial online services that contain information about IBM products include:

- CompuServe
Use the following GO words: APTIVA, IBMPS2, ThinkPad, PowerPC, ValuePoint, IBMSVR, or IBMOBI.
- PRODIGY
Use the Jump command; type **IBM** and select **PC Product Support**.
- America Online
Use the “Go to” keyword **IBM Connect**.

On the World Wide Web, the IBM Personal Computers home page has information about IBM Personal Computer products and support. The address for the IBM Personal Computer home page is:

<http://www.pc.ibm.com>

Getting Information by Fax

If you have a touch-tone telephone and access to a fax machine, in the U.S. and Canada you can receive by fax free marketing and technical information on many topics, including hardware, operating systems, and local area networks (LANs). You can call the IBM PC Company Automated Fax System 24 hours a day, 7 days a week. Follow the recorded instructions, and the requested information will be sent to your fax machine.

To access the IBM PC Company Automated Fax System, do the following:

- In the U.S., call 1-800-426-3395.
- In Canada, call 1-800-465-3299.

Getting Help Online

Online Housecall is a remote communication tool that allows an IBM HelpWare technical-support representative to access your PC by modem. Many problems can be remotely diagnosed and corrected quickly and easily. In addition to a modem, a remote-access application program is required. This service is not available for servers. There might be a change for this service, depending on the request.

For more information about configuring your PC for Online Housecall:

- In the U.S., call 1-800-772-2227.
- In Canada, call 1-800-565-3344.

- In all other countries, contact your IBM reseller or IBM marketing representative.

Getting Help by Telephone

During the warranty period, you can get help and information by telephone through the IBM HelpWare PC Support Line. Expert technical-support representatives are available to assist you with questions you might have on the following:

- Setting up your computer and IBM monitor
- Installing and setting up IBM options purchased from IBM or an IBM reseller
- 60-day, preinstalled-operating-system support
- Arranging for service (on-site or carry-in)
- Arranging for overnight shipment of customer-replaceable parts

In addition, if you purchased an IBM PC Server, you are eligible for Server Startup Support for 90 days after installation. This service provides assistance for:

- Setting up your network operating system
- Installing and configuring interface cards
- Installing and configuring network adapters

Please have the following information ready when you call:

- Serial numbers of your computer, monitor, and other components, or your proof of purchase

- Description of the problem
- Exact wording of any error messages
- Hardware and software configuration information for your system

If possible, be at your computer when you call.

These services are available 24 hours a day, 7 days a week (excluding some holidays).¹

- In the U.S. and Puerto Rico, call 1-800-772-2227.
- In Canada, call 1-800-565-3344.
- In all other countries, contact your IBM reseller or IBM marketing representative.

Getting Help Around the World

If you travel with your computer or need to move it to another country, you can register for International Warranty Service. When you register with the International Warranty Service Office, you will receive an International Warranty Service Certificate that is honored virtually worldwide, wherever IBM or IBM resellers sell and service IBM PC products.

For more information or to register for International Warranty Service in the U.S. or Canada, call 1-800-497-7426.

¹ Response time may vary depending on the number and complexity of incoming calls.

Purchasing Additional HelpWare Services

During and after the warranty period, you can purchase additional HelpWare services, such as support for IBM and non-IBM hardware, operating systems, and application programs; network setup and configuration; upgraded or extended hardware repair services; and custom installations. Service availability and name might vary by country.

Enhanced PC Support Line

Enhanced PC Support is available for desktop and mobile IBM computers that are not connected to a network. Technical support is provided for IBM computers and IBM or non-IBM options, operating systems, and application programs on the Supported Products list.

This service includes technical support for:

- Installing and configuring your out-of-warranty IBM computer
- Installing and configuring non-IBM options in IBM computers
- Using IBM operating systems in IBM and non-IBM computers
- Using application programs and games
- Tuning performance
- Installing device drivers remotely
- Setting up and using multimedia devices
- Identifying system problems

- Interpreting documentation

You can purchase this service on a per-call basis, as a multiple-incident package, or as an annual contract with a 10-incident limit. For more information about purchasing Enhanced PC Support, see “Ordering Support Line Services” on page 67.

900-Number Operating System and Hardware Support Line

In the U.S., if you prefer to obtain technical support on a pay-as-you go basis, you can use the 900-number support line. The 900-number support line provides the same support as the Enhanced PC Support line, except for application and non-IBM option support.

To access this support, call 1-900-555-CLUB (2582). You will be notified of the charge per minute.

Network and Server Support Line

Network and Server Support is available for simple or complex networks made up of IBM servers and workstations using major network operating systems. In addition, many popular non-IBM adapters and network interface cards are supported.

This service includes all of the features of the Enhanced PC Support Line, plus:

- Installing and configuring client workstations and servers

- Identifying system problems and correcting problems on the client or the server
- Using IBM and non-IBM network operating systems
- Interpreting documentation

You can purchase this service on a per-call basis, as a multiple-incident package, or as an annual contract with a 10-incident limit. For more information about purchasing Network and Server Support, see “Ordering Support Line Services.”

Ordering Support Line Services

Enhanced PC Support Line and Network and Server Support Line services are available for products on the Supported Products list. To receive a Supported Products list:

- In the U.S.:
 1. Call 1-800-426-3395.
 2. Select document number 11683 for Network and Server support.
 3. Select document number 11682 for Enhanced PC support.
- In Canada, contact IBM Direct at 1-800-465-7999, or:
 1. Call 1-800-465-3299.
 2. Select the HelpWare catalog.
- In all other countries, contact your IBM reseller or IBM marketing representative.

For more information or to purchase these services:

- In the U.S., call 1-800-772-2227.

- In Canada, call 1-800-465-7999.
- In all other countries, contact your IBM reseller or IBM marketing representative.

Warranty and Repair Services

You can upgrade your standard hardware warranty service or extend the service beyond the warranty period.

Warranty upgrades in the U.S. include:

- Carry-in service to on-site service

If your warranty provides carry-in repair service, you can upgrade to on-site repair service, either standard or premium. The standard upgrade provides a trained servicer within the next business day (9 a.m. to 5 p.m., local time, Monday through Friday). The premium upgrade provides 4-hour average response, 24 hours a day, 7 days a week.

- On-site service to premium on-site service

If your warranty provides for on-site service, you can upgrade to premium on-site service (4-hour average on-site response, 24 hours a day, 7 days a week).

You also can extend your warranty. HelpWare Warranty and Repair Services offers a variety of post-warranty maintenance options, including ThinkPad EasyServ Maintenance Agreements. Availability of the services varies by product.

For more information about warranty upgrades and extensions:

- In the U.S., call 1-800-426-7697.
- In Canada, call 1-800-465-7999.
- In all other countries, contact your IBM reseller or IBM marketing representative.

Obtaining IBM Operating System Updates

IBM provides update diskettes, called ServicePaks or corrective service diskettes (CSDs), to customers who report a DOS or OS/2 problem for which there is or will be a corrective program.

You can obtain update diskettes from the following sources:

- IBM PC Company BBS. See “Using Electronic Support Services” on page 63 for information on how to access this bulletin board system.
- OS/2 BBS. In the U.S. or Canada, call 1-800-547-1283.
- OS/2 Technical Support Center. In the U.S. or Canada, call 1-800-992-4777.
- World Wide Web. The address is <http://www.ibm.com>
- CompuServe and PRODIGY.
- IBM reseller or IBM marketing representative.

Ordering Publications

Additional publications are available for purchase from IBM. For a list of publications available in your country:

- In the U.S. and Puerto Rico, call 1-800-879-2755.
- In other countries, contact your IBM reseller or IBM marketing representative.

Appendix A. Computer Records

Serial Numbers and Keys

Record and retain the following information.

Product Name	Personal Computer
Serial Number (S/N)	_____
Machine Type/Model (M/T)	_____
Key Serial Number	_____
Key Address	_____

Your personal computer keys cannot be duplicated by locksmiths. If you lose them, order replacement keys from the key manufacturer. The key serial number and manufacturer's address are on a tag attached to the keys.

Anyone who has the key serial number and manufacturer's address can order duplicate keys, so store the tag in a safe place. If you record the key serial number on this page, either remove the page and store it in a secure place, or store this manual in a secure place when you are not using it.

The locations of the identification numbers are shown in the illustrations that follow.

Look for the serial number on the front of the system unit, at the lower right.

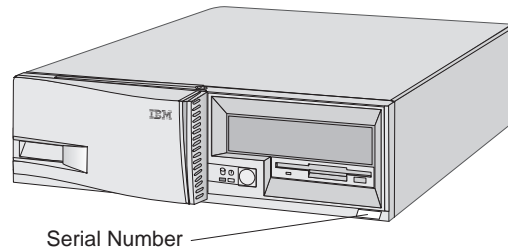

PC 330

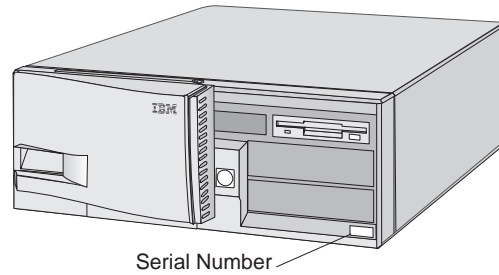

PC 350

Device Records

Use the following tables to keep a record of the options installed or attached to your personal computer. This information can be helpful when you install additional options in your personal computer or if you ever need to have your personal computer serviced.

<i>Figure 3. Internal and External Options</i>	
Location	Option Description
System Memory (Bank 1, SIMM 1)	<input type="checkbox"/> <u>4 MB</u> <input type="checkbox"/> <u>8 MB</u> <input type="checkbox"/> <u>16 MB</u> <input type="checkbox"/> <u>32 MB</u>
System Memory (Bank 1, SIMM 2)	<input type="checkbox"/> <u>4 MB</u> <input type="checkbox"/> <u>8 MB</u> <input type="checkbox"/> <u>16 MB</u> <input type="checkbox"/> <u>32 MB</u>
System Memory (Bank 2, SIMM 3)	<input type="checkbox"/> <u>4 MB</u> <input type="checkbox"/> <u>8 MB</u> <input type="checkbox"/> <u>16 MB</u> <input type="checkbox"/> <u>32 MB</u>
System Memory (Bank 2, SIMM 4)	<input type="checkbox"/> <u>4 MB</u> <input type="checkbox"/> <u>8 MB</u> <input type="checkbox"/> <u>16 MB</u> <input type="checkbox"/> <u>32 MB</u>
System Memory (Bank 0, DIMM)	<input type="checkbox"/> <u>8 MB</u> <input type="checkbox"/> <u>16 MB</u> <input type="checkbox"/> <u>32 MB</u>
Video Memory	<input type="checkbox"/> <u>1 MB</u> <input type="checkbox"/> <u>2 MB</u>
Expansion Slot 1	_____
Expansion Slot 2	_____
Expansion Slot 3	_____
Expansion Slot 4	_____
Expansion Slot 5	_____

<i>Figure 3. Internal and External Options</i>	
Location	Option Description
Processor	<input type="checkbox"/> <u>Type:</u> _____
Keyboard	_____
Mouse Connector	<input type="checkbox"/> <u>IBM Mouse</u> <input type="checkbox"/> <u>Other:</u> _____
Video Connector	_____
Parallel Connector	_____
Serial Connector A	_____
USB Connector 1	_____
USB Connector 2	_____
Infrared Connector	_____

Appendix B. Product Warranties, License Agreement, and Notices

Hardware Limited Warranty

The following is the statement of limited warranty for the United States, Canada, and Puerto Rico.

International Business Machines Corporation Armonk, New York, 10504

Statement of Limited Warranty

The warranties provided by IBM in this Statement of Limited Warranty apply only to Machines you originally purchase for your use, and not for resale, from IBM or your reseller. The term "Machine" means an IBM machine, its features, conversions, upgrades, elements, or accessories, or any combination of them. Unless IBM specifies otherwise, the following warranties apply only in the country where you acquire the Machine. If you have any questions, contact IBM or your reseller.

Machine: PC 330 (Type 6577) and PC 350 (Type 6587)

Warranty Period*: Three years

**Contact your place of purchase for warranty service information.*

Production Status

Each Machine is manufactured from new parts, or new and used parts. In some cases, the Machine may not be new and may have been previously installed. Regardless of the Machine's production status, IBM's warranty terms apply.

The IBM Warranty for Machines

IBM warrants that each Machine 1) is free from defects in materials and workmanship and 2) conforms to IBM's Official Published Specifications. The warranty period for a Machine is a specified, fixed period commencing on its Date of Installation. The date on your receipt is the Date of Installation, unless IBM or your reseller informs you otherwise.

During the warranty period IBM or your reseller, if authorized by IBM, will provide warranty service under the type of service designated for

the Machine and will manage and install engineering changes that apply to the Machine.

For IBM or your reseller to provide warranty service for a feature, conversion, or upgrade, IBM or your reseller may require that the Machine on which it is installed be 1) for certain Machines, the designated, serial-numbered Machine and 2) at an engineering-change level compatible with the feature, conversion, or upgrade. Many of these transactions involve the removal of parts and their return to IBM. You represent that all removed parts are genuine and unaltered. A part that replaces a removed part will assume the warranty service status of the replaced part.

If a Machine does not function as warranted during the warranty period, IBM or your reseller will repair it or replace it with one that is at least functionally equivalent, without charge. The replacement may not be new, but will be in good working order. If IBM or your reseller is unable to repair or replace the Machine, you may return it to your place of purchase and your money will be refunded.

If you transfer a Machine to another user, warranty service is available to that user for the remainder of the warranty period. You should give your proof of purchase and this Statement to that user. However, for Machines which have a life-time warranty, this warranty is not transferable.

Warranty Service

To obtain warranty service for the Machine, you should contact your reseller or call IBM. In the United States, call IBM at **1-800-772-2227**. In Canada, call IBM at **1-800-565-3344**. You may be required to present proof of purchase.

IBM or your reseller will provide certain types of repair and exchange service, either at your location or at IBM's or your reseller's service center, to restore a Machine to good working order.

When a type of service involves the exchange of a Machine or part, the item IBM or your reseller replaces becomes its property and the replacement becomes yours. You represent that all removed items are genuine and unaltered. The replacement may not be new, but will be in good working order and at least functionally equivalent to the item replaced. The replacement assumes the warranty service status of the

replaced item. Before IBM or your reseller exchanges a Machine or part, you agree to remove all features, parts, options, alterations, and attachments not under warranty service. You also agree to ensure that the Machine is free of any legal obligations or restrictions that prevent its exchange.

You agree to:

1. obtain authorization from the owner to have IBM or your reseller service a Machine that you do not own; and
2. where applicable, before service is provided —
 - a. follow the problem determination, problem analysis, and service request procedures that IBM or your reseller provide,
 - b. secure all programs, data, and funds contained in a Machine, and
 - c. inform IBM or your reseller of changes in a Machine's location.

IBM is responsible for loss of, or damage to, your Machine while it is 1) in IBM's possession or 2) in transit in those cases where IBM is responsible for the transportation charges.

Extent of Warranty

IBM does not warrant uninterrupted or error-free operation of a Machine.

The warranties may be voided by misuse, accident, modification, unsuitable physical or operating environment, improper maintenance by you, removal or alteration of Machine or parts identification labels, or failure caused by a product for which IBM is not responsible.

THESE WARRANTIES REPLACE ALL OTHER WARRANTIES OR CONDITIONS, EXPRESS OR IMPLIED, INCLUDING, BUT NOT LIMITED TO, THE IMPLIED WARRANTIES OR CONDITIONS OF MERCHANTABILITY AND FITNESS FOR A PARTICULAR PURPOSE. THESE WARRANTIES GIVE YOU SPECIFIC LEGAL RIGHTS AND YOU MAY ALSO HAVE OTHER RIGHTS WHICH VARY FROM JURISDICTION TO JURISDICTION. SOME JURISDICTIONS DO NOT ALLOW THE EXCLUSION OR LIMITATION OF EXPRESS OR IMPLIED WARRANTIES, SO THE ABOVE EXCLUSION OR LIMITATION MAY NOT APPLY TO YOU. IN THAT EVENT

SUCH WARRANTIES ARE LIMITED IN DURATION TO THE WARRANTY PERIOD. NO WARRANTIES APPLY AFTER THAT PERIOD.

Limitation of Liability

Circumstances may arise where, because of a default on IBM's part or other liability you are entitled to recover damages from IBM. In each such instance, regardless of the basis on which you are entitled to claim damages from IBM (including fundamental breach, negligence, misrepresentation, or other contract or tort claim), IBM is liable only for:

1. damages for bodily injury (including death) and damage to real property and tangible personal property; and
2. the amount of any other actual direct damages or loss, up to the greater of U.S. \$100,000 or the charges (if recurring, 12 months' charges apply) for the Machine that is the subject of the claim.

UNDER NO CIRCUMSTANCES IS IBM LIABLE FOR ANY OF THE FOLLOWING: 1) THIRD-PARTY CLAIMS AGAINST YOU FOR LOSSES OR DAMAGES (OTHER THAN THOSE UNDER THE FIRST ITEM LISTED ABOVE); 2) LOSS OF, OR DAMAGE TO, YOUR RECORDS OR DATA; OR 3) SPECIAL, INCIDENTAL, OR INDIRECT DAMAGES OR FOR ANY ECONOMIC CONSEQUENTIAL DAMAGES (INCLUDING LOST PROFITS OR SAVINGS), EVEN IF IBM OR YOUR RESELLER IS INFORMED OF THEIR POSSIBILITY. SOME JURISDICTIONS DO NOT ALLOW THE EXCLUSION OR LIMITATION OF INCIDENTAL OR CONSEQUENTIAL DAMAGES, SO THE ABOVE EXCLUSION OR LIMITATION MAY NOT APPLY TO YOU.

License Information

The license information in this booklet is for IBM and non-IBM logo programs covered by the IBM International Program License Agreement.

Some programs referred to in this booklet might not be available in all languages or in all countries. Some programs might be different from the retail versions and might be customized to work only with the product with which they are shipped.

Program Name

System Programs

Additional Terms and Conditions

Authorization for Copy and Use on Home/Portable Computer: Not applicable for these programs.

Transfer of Program: Programs are transferable with written consent from the party (IBM or its reseller) from whom you acquired the program.

Proof of Entitlement: The Proof of Purchase for the computer that contains these programs should be retained in order to support eligibility provided by IBM or its authorized reseller for warranty services, future upgrade program prices (if announced), potential special or promotional opportunities (if any), and as evidence of the end user's authorized use of these IBM-licensed programs.

Technical support for programs provided with your system is available on a limited basis. See the publications provided with your system for details.

Program Services

Availability/Duration of Program Services: No program services are available for these programs.

Statement of Service: No program services are available. These licensed programs are provided "AS IS."

Warranty

System Programs – No.

PROGRAMS DESIGNATED AS "NO" ARE PROVIDED WITHOUT A PROGRAM WARRANTY. THEY ARE PROVIDED "AS IS" WITHOUT WARRANTY OF ANY KIND. IBM DISCLAIMS ALL WARRANTIES FOR THESE PROGRAMS, EITHER EXPRESS OR IMPLIED, INCLUDING BUT NOT LIMITED TO IMPLIED WARRANTIES OF MERCHANTABILITY AND FITNESS FOR A PARTICULAR PURPOSE.

U.S. Government Users Restricted Rights

U.S. Government Users Restricted Rights—Use, duplication, or disclosure restricted by the GSA ADP Schedule Contract with IBM Corporation.

Other Documentation

Any other documentation with respect to its licensed program, including any such documentation referenced herein, is provided for information purposes only and does not extend or modify the material contained in the License information.

Other Additional Terms and Conditions

These additional terms and conditions apply to device drivers, utility programs, and flash BIOS code ("System Programs") shipped with an IBM system ("System") on diskette or CD-ROM, preinstalled on a System, created on diskette from a CD-ROM, System, or Local Area Network (LAN) using a diskette-creation program provided by IBM, or placed on a LAN. A System includes IBM computers, features, conversions, upgrades, and options, either separately or in any combination.

If you are the rightful possessor of a System, or if you have obtained the System Programs for the sole purpose of maintaining a System, IBM or the applicable IBM country organization grants you a license to use the System Programs as part of or in conjunction with a System, or to restore and maintain the System Programs. You can make copies of the System Programs and distribute them to the rightful possessor of a System and install the System Programs for a rightful possessor (but only to the extent necessary to restore or maintain the System), provided that you supply such party a copy of this Agreement. Initial use of the System Programs by such party shall indicate acceptance of this agreement.

YOU MUST REPRODUCE THE COPYRIGHT NOTICE AND ANY OTHER LEGEND OF OWNERSHIP ON EACH COPY, OR PARTIAL COPY, OF A PROGRAM YOU CREATE ON DISKETTE OR OTHER PORTABLE MEDIUM.

Notices

References in this publication to IBM products, programs, or services do not imply that IBM intends to make these available in all countries in which IBM operates. Any reference to an IBM product, program, or service is not intended to state or imply that only that IBM product, program, or service may be used. Subject to IBM's valid intellectual property or other legally protectable rights, any functionally equivalent product, program, or service may be used instead of the IBM product, program, or service. The evaluation and verification of operation in conjunction with other products, except those expressly designated by IBM, are the responsibility of the user.

IBM may have patents or pending patent applications covering subject matter in this document. The furnishing of this document does not give you any license to these patents. You can send license inquiries, in writing, to:

IBM Director of Licensing
IBM Corporation
500 Columbus Avenue
Thornwood, NY 10594
U.S.A.

Trademarks

The following terms are trademarks of the IBM Corporation in the United States or other countries or both:

HelpWare	OS/2
PowerPC	ValuePoint
PS/2	ThinkPad

The following terms are trademarks of other companies:

America Online	America Online, Inc.
CompuServe	CompuServe Incorporated
CoSession	Triton Technology Inc.
DEC	Digital Equipment Corporation
Pathworks	
Intel	Intel Corporation
NetWare	Novell, Inc.
Novell	Novell, Inc.
OverDrive	Intel Corporation
PCMCIA	Personal Computer Memory Card International Association
Pentium	Intel Corporation
PRODIGY	Prodigy Services Company
QAPLus/PRO	DiagSoft, Inc.
QAPLus/WIN	DiagSoft, Inc.
S3	S3 Incorporated
Solaris	Sun Microsystems, Inc.
UnixWare	Novell, Inc.
VESA	Video Electronics Standards Association

Microsoft, Windows, Windows NT, MS-DOS, and the Windows 95 logo are trademarks or registered trademarks of Microsoft Corporation.

UNIX is a registered trademark in the United States and other countries licensed exclusively through X/Open Company Limited.

Other company, product, and service names, which may be denoted by a double asterisk (**), may be trademarks or service marks of others.

Electronic Emission Notices

Federal Communications Commission (FCC) Statement

Note: This equipment has been tested and found to comply with the limits for a Class B digital device, pursuant to Part 15 of the FCC Rules. These limits are designed to provide reasonable protection against harmful interference in a residential installation. This equipment generates, uses, and can radiate radio frequency energy and, if not installed and used in accordance with the instructions, may cause harmful interference to radio communications. However, there is no guarantee that interference will not occur in a particular installation. If this equipment does cause harmful interference to radio or television reception, which can be determined by turning the equipment off and on, the user is encouraged to try to correct the interference by one or more of the following measures:

- Reorient or relocate the receiving antenna.
- Increase the separation between the equipment and receiver.
- Connect the equipment into an outlet on a circuit different from that to which the receiver is connected.
- Consult an IBM authorized dealer or service representative for help.

Properly shielded and grounded cables and connectors must be used in order to meet FCC emission limits. Proper cables and connectors are available from IBM authorized dealers. IBM is not responsible for any radio or television interference caused by using other than recommended cables and connectors or by unauthorized changes or modifications to this equipment. Unauthorized changes or modifications could void the user's authority to operate the equipment.

This device complies with Part 15 of the FCC Rules. Operation is subject to the following two conditions: (1) this device may not cause harmful interference, and (2) this device must accept any interference received, including interference that may cause undesired operation.

Industry Canada Class B Emission Compliance Statement

This Class B digital apparatus meets the requirements of the Canadian Interference-Causing Equipment Regulations.

Avis de conformité à la réglementation d'Industrie Canada

Cet appareil numérique de la classe B respecte toutes les exigences du Règlement sur le matériel brouilleur du Canada.

Telecommunication Notices

Federal Communications Commission (FCC) and Telephone Company Requirements

1. This adapter complies with Part 68 of the FCC rules. A label is affixed to the adapter that contains, among other things, the FCC registration number, USOC, and Ringer Equivalency Number (REN) for this equipment. If these numbers are requested, provide this information to your telephone company.

A second FCC registration label is also provided. You may attach the label to the exterior of the computer in which you install the IBM modem, or you may attach the label to the external DAA, if you have one. Place the label in a location that is easily accessible, should you need to provide the label information to the telephone company.

2. The REN is useful to determine the quantity of devices you may connect to your telephone line and still have those devices ring when your number is called. In most, but not all areas, the sum of the RENs of all devices should not exceed five (5). To be certain of the number of devices you may connect to your line, as determined by the REN, you should call your local telephone company to determine the maximum REN for your calling area.
3. If the adapter causes harm to the telephone network, the telephone company may discontinue your service temporarily. If possible,

they will notify you in advance; if advance notice is not practical, you will be notified as soon as possible. You will be advised of your right to file a complaint with the FCC.

4. Your telephone company may make changes in its facilities, equipment, operations, or procedures that could affect the proper operation of your equipment. If they do, you will be given advance notice to give you an opportunity to maintain uninterrupted service.
5. If you experience trouble with this product, contact your authorized reseller, or call IBM. In the United States, call IBM at **1-800-772-2227**. In Canada, call IBM at **1-800-565-3344**. You may be required to present proof of purchase.

The telephone company may ask you to disconnect the adapter from the network until the problem has been corrected, or until you are sure the adapter is not malfunctioning.

6. No customer repairs are possible to the adapter. If you experience trouble with the adapter, contact your Authorized Reseller or see the Diagnostics section of this manual for information.
7. This adapter may not be used on coin service provided by the telephone company. Connection to party lines is subject to state tariffs. Contact your state public utility commission or corporation commission for information.
8. When ordering network interface (NI) service from the local Exchange Carrier, specify service arrangement USOC RJ11C.

Canadian Department of Communications Certification Label

NOTICE: The Canadian Department of Communications label identifies certified equipment. This certification means that the equipment meets certain telecommunications network protective, operational, and safety requirements. The Department does not guarantee the equipment will operate to the user's satisfaction.

Before installing this equipment, users should ensure that it is permissible to be connected to the facilities of the local telecommunications company. The equipment must also be installed using an acceptable method of connection. In some cases, the company's inside wiring associated with a single line individual service may be extended by means of a certified connector assembly (telephone extension cord). The customer should be aware that compliance with the above conditions may not prevent degradation of service in some situations.

Repairs to certified equipment should be made by an authorized Canadian maintenance facility designated by the supplier. Any repairs or alterations made by the user to this equipment, or equipment malfunctions, may give the telecommunications company cause to request the user to disconnect the equipment.

Users should ensure for their own protection that the electrical ground connections of the power utility, telephone lines, and internal metallic water pipe system, if present, are connected together. This precaution may be particularly important in rural areas.

Caution: Users should not attempt to make such connections themselves, but should contact the appropriate electric inspection authority, or electrician, as appropriate.

NOTICE: The LOAD NUMBER (LN) assigned to each terminal device denotes the percentage of the total load to be connected to a telephone loop which is used by the device, to prevent overloading. The termination on a loop may consist of any combination of devices subject only to the requirement that the sum of the LOAD NUMBERS of all the devices does not exceed 100.

Étiquette d'homologation du ministère des Communications du Canada

AVIS : L'étiquette du ministère des Communications du Canada identifie le matériel homologué. Cette étiquette certifie que le matériel est conforme à certaines normes de protection, d'exploitation et de sécurité des réseaux de télécommunications. Le ministère n'assure toutefois pas que le matériel fonctionnera à la satisfaction de l'utilisateur.

Avant d'installer ce matériel, l'utilisateur doit s'assurer qu'il est permis de le raccorder aux installations de l'entreprise locale de télécommunications. Le matériel doit également être installé en suivant une méthode acceptée de raccordement. L'abonné ne doit pas oublier qu'il est possible que la conformité aux conditions énoncées ci-dessus n'empêchent pas la dégradation du service dans certaines situations.

Les réparations de matériel homologué doivent être effectuées par un centre d'entretien canadien autorisé désigné par le fournisseur. La compagnie de télécommunications peut demander à l'utilisateur de débrancher un appareil à la suite de réparations ou de modifications effectuées par l'utilisateur ou à cause d'un mauvais fonctionnement.

Pour sa propre protection, l'utilisateur doit s'assurer que tous les fils de mise à la terre de la source d'énergie électrique, des lignes téléphoniques et des canalisations d'eau métalliques, s'il y en a, sont raccordés ensemble. Cette précaution est particulièrement importante dans les régions rurales.

Avertissement : l'utilisateur ne doit pas tenter de faire ces raccordements lui-même, il doit avoir recours à un service d'inspection des installations électriques ou à un électricien, selon le cas.

AVIS : L'INDICE DE CHARGE (IC) assigné à chaque dispositif terminal indique, pour éviter toute surcharge, le pourcentage de la charge totale qui peut être raccordé à un circuit téléphonique bouclé utilisé par ce dispositif. L'extrémité du circuit bouclé peut consister en n'importe quelle combinaison de dispositifs pourvu que la somme des INDICES DE CHARGE de l'ensemble des dispositifs ne dépasse pas 100.

Power Cord Notice

For your safety, IBM provides a power cord with a grounded attachment plug to use with this IBM product. To avoid electrical shock, always use the power cord and plug with a properly grounded outlet.

IBM power cords used in the United States and Canada are listed by Underwriter's Laboratories (UL) and certified by the Canadian Standards Association (CSA).

For units intended to be operated at 115 volts: Use a UL-listed and CSA-certified cord set consisting of a minimum 18 AWG, Type SVT or SJT, three-conductor cord, a maximum of 15 feet in length and a parallel blade, grounding-type attachment plug rated 15 amperes, 125 volts.

For units intended to be operated at 230 volts (U.S. use): Use a UL-listed and CSA-certified cord set consisting of a minimum 18 AWG, Type SVT or SJT, three-conductor cord, a maximum of 15 feet in length and a tandem blade, grounding-type attachment plug rated 15 amperes, 250 volts.

For units intended to be operated at 230 volts (outside the U.S.): Use a cord set with a grounding-type attachment plug. The cord set should have the appropriate safety approvals for the country in which the equipment will be installed.

IBM power cords for a specific country are usually available only in that country:

IBM Power Cord Part Number	Used in These Countries
13F9940	Argentina, Australia, China (PRC), New Zealand, Papua New Guinea, Paraguay, Uruguay, Western Samoa
13F9979	Afghanistan, Algeria, Andorra, Angola, Austria, Belgium, Benin, Bulgaria, Burkina Faso, Burundi, Cameroon, Central African Rep., Chad, Czech Republic, Egypt, Finland, France, French Guiana, Germany, Greece, Guinea, Hungary, Iceland, Indonesia, Iran, Ivory Coast, Jordan, Lebanon, Luxembourg, Macau, Malagasy, Mali, Martinique, Mauritania, Mauritius, Monaco, Morocco, Mozambique, Netherlands, New Caledonia, Niger, Norway, Poland, Portugal, Romania, Senegal, Slovakia, Spain, Sudan, Sweden, Syria, Togo, Tunisia, Turkey, former USSR, Vietnam, former Yugoslavia, Zaire, Zimbabwe
13F9997	Denmark
14F0015	Bangladesh, Burma, Pakistan, South Africa, Sri Lanka

IBM Power Cord Part Number	Used in These Countries
14F0033	Antigua, Bahrain, Brunei, Channel Islands, Cyprus, Dubai, Fiji, Ghana, Hong Kong, India, Iraq, Ireland, Kenya, Kuwait, Malawi, Malaysia, Malta, Nepal, Nigeria, Polynesia, Qatar, Sierra Leone, Singapore, Tanzania, Uganda, United Kingdom, Yemen, Zambia
14F0051	Liechtenstein, Switzerland
14F0069	Chile, Ethiopia, Italy, Libya, Somalia
14F0087	Israel
1838574	Thailand
62X1045	Bahamas, Barbados, Bermuda, Bolivia, Brazil, Canada, Cayman Islands, Colombia, Costa Rica, Dominican Republic, Ecuador, El Salvador, Guatemala, Guyana, Haiti, Honduras, Jamaica, Japan, Korea (South), Liberia, Mexico, Netherlands Antilles, Nicaragua, Panama, Peru, Philippines, Saudi Arabia, Suriname, Taiwan, Trinidad (West Indies), United States of America, Venezuela

Numerics

- 1-800 telephone assistance 65
- 900 number support 66

A

- adapter
 - conflicts 50, 51, 52
 - problems with 47
- adapters, adding 1
- adjusting chair 9
- administrator password
 - changing 20
 - deleting 21
 - format of 21
 - setting 20
 - using 20
- administrator password, access controlled by 20
- advanced power management
 - in system software 3
 - setting 22
 - using 21
- air circulation 9, 10
- air vents 10
- America Online 64
- antiglare filter 10
- arranging workspace 9
- assistance 63
- audio
 - features 7

B

- backing up hard disk drive 41
- basic input/output system, updating 27
- battery
 - dead 47
 - notice vi
 - replacing 40, 47
 - safety 47
- bays, drive 4, 7
- beeps 13, 44
- BIOS, updating 27
- boot sequence error 52
- bulletin boards 63

C

- cable lengths 10
- cache memory 7, 49
- care and cleaning of computer 39
- CD-ROM drives
 - adding 4
 - using 36
- CDs, handling 36
- chair adjustments 9
- circulation, air 10
- cleaning
 - compact discs 36
 - computer 39
 - keyboard 39
 - monitor 10
 - monitor screen 39
 - mouse 40

- clicking with a mouse 14
- comfort 9
- compact discs, handling 36
- CompuServe 64
- computer records 69
- configuration
 - See also* Configuration/Setup Utility
 - change 48
 - video error 53
 - with Plug and Play 2
- Configuration/Setup Utility
 - at start-up 13
 - date and time setting 47, 48
 - time and date setting 47, 48
 - using 15—25
- controls 11, 12
- copying diskettes 35
- cords, power 10
- corrective service diskette (CSD) 68
- CoSession for Windows 45
- cover, locking 37
- CSD 68

D

- damage, preventing 39, 41
- data collaboration
 - See* audio
- date, setting 17, 47, 48
- DDC (display data channel) 24
- device drivers, video 25
- device records 71

- diagnostic error messages 46
- diagnostic programs 3, 44
- diagnostic tools 43
- DIMMs 7
- diskette drives
 - adding 4
 - eject button 12
 - indicator light 12, 55
 - problems with 49, 50, 55
 - record of 72
 - support for 7
 - types 28, 35
- diskettes
 - capacities 28, 29, 35
 - copying 35
 - ejecting 12, 33
 - formatting 35
 - handling 31
 - inserting 33
 - labeling 32
 - problems with 50
 - removing 12, 33
 - storing 31
 - using 28—35
 - write-protecting 34
- display
 - See* monitor
- display data channel (DDC) 24
- Display Power Management Signaling (DPMS) 22
- door, locking 37
- double-clicking with a mouse 14
- DPMS (Display Power Management Signaling) 22

- drag and drop 14
- dragging with a mouse 14
- drive bays 4, 7
- drivers, video 25
- dropping with a mouse 14
- dual in-line memory modules (DIMMs) 7
- dual mode 18

E

- ease-of-use features 2
- ECP/EPP, support for 2, 7
- electrical outlets 10
- electronic emission notices 78
- electronic support 63
- enhanced parallel port, support for 2, 7
- error messages 45
- Ethernet 4
- expansion slots
 - available 4, 7
 - installing PCI adapters in 1
- extended capabilities port, support for 2, 7
- extension cords 10

F

- fatigue 9
- fax, getting information by 64
- features, record of 71
- fee services 66
- fixed disk drives
 - See hard disk drives

- flash memory 7, 27
- flicker 56
- flicker, reducing 24
- floppy disks
 - See diskettes
- floppy drives
 - See diskette drives
- formatting diskettes 35

G

- glare, reducing 9

H

- hard disk drives
 - adding 4
 - backing up 41
 - indicator light 11
 - problems with 50, 53
 - record of 72
 - support for 2, 7
 - with power management 22
- help 63
- HelpWare 65
- home page, IBM Personal Computer 64

I

- identification numbers for hardware 69
- infrared connector 2, 7
- interlaced refresh rate 24
- intermittent problems 57

international warranty service 65

K

key serial numbers 69

keyboard

angle of 9

arm and wrist position 9

cleaning 39

locked by password 18

locking 38

problems with 49, 57

speed, changing 23

support for 7

keys 37, 69

L

LAN wake-up 4, 7, 23

laser compliance statement vii

license agreement 73, 75

license, system programs 75

lighting 9

lights, indicator 11, 12, 55, 57

locks 12, 37, 57

M

memory

addresses used by Plug and Play 59

cache 7, 49

configuration change 48

counting 13, 44, 58

DIMMs 7

memory (*continued*)

failure during testing 49

flash 7

modules, adding 26

not enough 58

parity failure 47

resource, unavailable 51, 52

ROM error 52

SIMMs 7

supported 7

used by TSR programs 62

video 7

microprocessor

Pentium 1, 7

problems with 47

speed 7

upgrading 1, 7

with advanced power management 22

modem 23

monitor

adjusting for comfort 3

adjusting of 9

cleaning 39

dusting of 10

flicker 24

placement of 9

power-management states 22

problems with 56

refresh rate 24

resolution 24

settings 24

standby 22

support for 7

- monitor (*continued*)
 - suspend 22
 - with advanced power management 22
- mouse
 - cleaning 40
 - clicking 14
 - double-clicking 14
 - dragging 14
 - dropping 14
 - locked by password 18
 - pointing 14
 - problems with 58
 - PS/2 13, 18
 - serial 13, 18
 - support for 7
 - using 13
 - with unattended start mode 19
- moving the computer 41

N

- network and server startup support 65
- network and server support services, fee 66
- networking 4, 23
- noninterlaced refresh rate 24
- notices 73

O

- office space, arranging 9
- Online Housecall 64
- online information services 63

- operating system
 - not found 53
 - support for 3, 7
- operating system updates 68
- option does not work 59
- option files, installing 62
- options, installed 71
- ordering support line services 67
- orderly shutdown 14
- OverDrive socket, Pentium 7

P

- parallel port
 - available 7
 - ECP/EPP 2
 - number of 60
- passwords
 - administrator 7, 20
 - dual mode 18
 - power-on 7, 13, 17
 - prompt 18
 - setting and changing 17—21
 - support for 7
 - Unattended Start mode 18
- PC Cards 4
- PC support services, fee 66
- PCI
 - adding adapters 1
 - bus 1
 - conflicts with ISA legacy 50, 51, 52
 - I/O resource problem 51
 - memory problems 51, 52

PCI (*continued*)

- read-only memory error 52
- riser card 1, 7

PCMCIA

- connector, locking 37
- support for 4

Pentium OverDrive socket 7

peripheral component interconnect

See PCI

Personal Computer Memory Card International Association

See PCMCIA

planning workspace 9

Plug and Play 2, 7, 59

pointing with a mouse 14

POST

- at start-up 13
- beep codes 44
- error messages 45—53
- problem detection by 43
- updating 27

power

- cord lengths 10
- cords 10
- indicator light 11
- management 22
- specifications 7
- switch 11

power cord notice 81

power management

See advanced power management

power-on password

- changing 19
- deleting 20

power-on password (*continued*)

- format of 19
- setting 19
- unknown 20
- using 18
- using at start-up 13

power-on self-test

See POST

printer does not work 60

printers

printers, support for 2

privileged-access password

See administrator password

problems, solving

- adapter 47
- adapter conflicts 50, 51, 52
- battery, dead 47
- boot sequence error 52
- cache memory 49
- clock 48
- configuration change 48
- CoSession for Windows 45
- date and time 48
- diagnostic tools, using 43
- diagnostics, using 3
- diskette drive 49, 50, 55
- error messages 45
- hard disk drive 50, 53
- I/O resources 51
- indicator lights 57
- intermittent 57
- keyboard 49, 57
- locks 57

problems, solving (*continued*)
 memory 47, 48, 49, 51, 52, 58
 microprocessor 47
 monitor 56
 mouse 58
 operating system not found 53
 option does not work 59
 parallel ports, number of 60
 PCI adapter 52
 POST error codes 46
 POST, using 43
 printer does not work 60
 QAPLus/PRO 44
 QAPLus/WIN-WIN 44
 serial ports, number of 60
 software 61
 startup 13
 startup sequence error 52
 system board 47
 time and date 48
 video configuration 53
processor
 See microprocessor
PRODIGY 64
publications, ordering 68

Q

QAPLus/PRO 44
QAPLus/WIN-WIN 44

R

recording identification numbers 69
records, device and feature 71
refresh rate 24
remote technical support 64
resolution 24
riser card 1, 7

S

S3 Trio64V+ 25
safety, electrical v
screen filter 10
screen problems 56
security
 administrator password 20
 features 3, 7
 keys 37
 locks 12, 37
 power-on password 17
 write-protecting diskettes 34
serial numbers 69, 70
serial ports
 available 7
 infrared connector 2
 number of 60
 universal serial bus connectors 2
server startup support 65
server support 65
service and support 3
ServicePak 68
services, fee 66

Setup Utility

See Configuration/Setup Utility

shutting down the computer 14

SIMMs 7

single in-line memory modules (SIMMs) 7

software error messages 46, 61

solving problems 63

standby mode for monitor 22

starting the computer 13

startup sequence error 52

status indicators 11, 12, 55, 57

summary, system 16

support 3

support line services, ordering 67

surge protectors 10

suspend mode for monitor 22

system management

LAN wake-up 4, 7, 23

setting 23

wake up on alarm 23

wake up on LAN 4, 7, 23

wake up on ring 7, 23

system programs, updating 27

system summary 16

T

technical support, fee 66

technical support, remote 64

technical support, warranty 65

telecommunication notices 79

telephone assistance 65

terminate-and-stay-resident (TSR) programs 62

time, setting 17, 47, 48

token ring 4

trademarks 77

troubleshooting

See problems, solving

TSR programs 62

turning off the computer 14

turning on the computer 13

typematic rate 23

U

Unattended Start mode 18

universal serial bus connectors 2, 7

updates, operating system 68

V

venting of hot air 10

video

configuration error 53

device drivers, installing 25

port 7

S3 Trio64V+ 25

W

wake up on alarm 7, 23

wake up on LAN 4, 7, 23

wake up on ring 7, 23

warranty 73

warranty extensions and upgrades 67

warranty service 65
work area, arranging 9
World Wide Web home page 64



Part Number: 84H0294

Printed in U.S.A.

June 1996

84H0294

